



Graphic Commerce Ltd.

2023 Supply & Equipment Catalogue

COMPLETE INDEX ON NEXT PAGE - CLICK AN ITEM FOR DIRECT ACCESS TO GO TO CATALOGUE PAGE

Index on Page 2

Signwriting
Supplies

Screen Printing
Inks, Supplies
and Equipment

Computer Cut
Vinyls

Ink Jet Films

Exhibit Display

Movie & TV Set
Supplies

Decal Films

Banner Materials

Plastics for Signs

Sign Stands

Sign Brushes

Art Room
Supplies



PRESSURE SENSITIVE FILMS



SIGN PAINT SUPPLIES



BANNER MATERIALS



PLASTICS FOR SIGNS



DIGITAL IMAGING-INK JET FILMS



SIGN HOLDERS. BANNER STANDS



SCREEN INKS AND SUPPLIES



SCREEN PRINTING EQUIPMENT



SIGN BRUSHES

1200 AEROWOOD DRIVE, UNIT 17 & 18, MISSISSAUGA, ONTARIO L4W 2S7

PHONE: 905-624-3124

TOLL FREE: 1-800-543-2796 • FAX: 905-624-3653

www.graphiccommerce.com • Email: info@graphiccommerce.com

WEBSITE INDEX

"A Frames" p.46-47 **A**
 ABS Plastic p.31
 Adhesives - Cements p.29,66
 Aluminum Foil Pressure Sensitivte p.17
 Aluminum Sign Panels p.30
 Anti Grafitti Film & Paint p.28A,28B
 Application Tape (Pre Mask) p10 **B**
 BANNER MATERIALS p.32,32B,32C
 Banner Stands p.48,49,47
 Blades-Cutting tools p.76-77
 Blades-Plotters p.9A,9B
 Blockout-Screens p.67
 Brayers-"Speedball" p.12A
 Bronze Powders p.55
 Brushes-Signwriters, Artists p.42-45
 "CPS" CHEMICALS p.64 **C**
 Cans-Mixing p.62
 Cardboard-Showcard p.39
 Cartridges-Ink Jet p.14
 Cements p.29,66
 Chalkboard Paint p.35
 "Chromatic" Paints p.35-37
 Cinema Set Supplies p.40,78,15,38
 Clamps-Screen Printing p.63
 Computer-Cut Films p.1 to 9
 Corner Rounders p.14
 "Coroplast" p.30
 "Crezon" p.30
 Cutting Mat p.75
 Cutting Tools p.76-77 **D**
 Decal Film Sheet Stock p.16-17
 Degreasers-Screens p.64,66
 Dry Erase Film p.9,22A
 Drying Racks Screen Printing p.71
 EASELS-CARDBOARD p.39 **E**
 "Eco Brand" Screen Chemicals p.64
 Emulsion Coater p.67
 Emulsions-Screen Printing p.70
 Emulsion Removers p.64,67
 Enamels-Sign p.34-37
 Enamel-Screen Print p.53
 Etch-Vinyl p.5
 Exposure Calculator p.66 **F**
 FABRIC-MESH SCREEN FRAME p.65
 Flattening Agents-Screen p.55
 Floor Graphic Films p.20,23B,27
 Fluorescent Paint p.35
 Fluorescent Vinyl p.4
 Foil-Pressure Sensitive p.17
 "Fome Cor" p.30
 Frames-Screen Printing p.65
 "Frog Juice" p.36-Discontinued
 Frosted Etch Film p.5 **G**
 "GATERFOAM" p.30
 Glass Cleaner p.62
 Glass Etch film p.5

G
 GOLD LEAF & SUPPLIES p.38
 Grommets & Supplies p.33 **H**
 HAZE REMOVER p.64,67
 Heat Transfer Paper p.60
 Hinge Clamps - Screen Printing p.63
 H.I.P.S. Styrene p.31
 Hydrogen Peroxide Activator p.69
I
 INK-JET MEDIA - FILMS p.18-28
 Ink-Jet Cartridges p.14
 Inks - Screen Printing p.50-60
K
 "KIMODESK" FILM p.74
 Knives - Cutting p.76-77
L
 LAMINATING FILMS p.23A,28,17,32C
 "Lexan" p.31
M
 MAGNETIC VINYL p.15
 Magnifier - Linen Testor p.66
 Mahl Stick p.40
 Masking Films p.68, 9
 Masking Tape p.41
 Mat - Cutting p.75
 Mesh - Screen Printing p.65
 Mixing Can p.62
 Mounting Films p.23B, 41
O
 "OLFA" CUTTING TOOLS p.77
 "ONE SHOT PAINT" Products p.34-37
 "One Man Squeegee Printer p.72
P
 PAINTS - SIGN p.34-37
 Paint Mask p.10
 "Pantone" Guides p.74
 Paper- Pounce, Poster, Wrapping p.39
 "Pet G" Plastic Sheet p.31
 Pencils - "Stabilo" p.79
 Perf - Window p.22
 "Peterboro" Showcard Board p.39
 Pin Striping Brushes p.44,44A
 Pin Striping Tapes p.41
 Plastic Sheets p.30,31
 Plastisol Screen Printing Ink p.60
 Plotter Cutting Blades p.9A,9B
 Polycarbonate-"Lexan" p.31
 Polyester - Screen mesh p.65
 Polyester - Overlay p.74
 Pounce Wheel - p.40
 Pre-Mask Application Tape p.10
 Pressess - Screen Printing p.72-73
 Primers - Paint p.36,37

R
 RACK - DRYING p.71
 Rack - Vinyl Roll Storage p.75
 "Rapid Tac" & "Rapid Remover" p.11
 Reflective Films p.7
 Registration Guides p.62
 Rivet Brushes p.12A
 Rollers - Paint p.38
 Rulers - Safety **S**
 SANDBLAST STENCIL p.14
 Scissors p.77
 Scoop Coater p.67
 "Scotchlite" Reflective film p.7
 Scraper - window p.77
 Screen Inks p.50-60
 Screen Washes p.62,64
 Screens - made up p.65
 "SEAL" Brand Products p.28,32B,32C
 See-Thru Vinyl
 Showcard Board p.39
 Sign Blanks p.46
 Sign Stands - Holders p.46-49
 "SINTRA" PVC Sheets p.30
 Solvents p.62
 Spatulas p.63
 Spot Cleaner p.60
 "SPRAYWAY" Aerosols p.62
 Squeegee applicators p.12,12A
 Squeegee - Screen Printing p.63
 "STABILO" pencil p.78
 Static Cling Vinyl
 Stand-Offs p.47
 Staple Tape p.66
 Stencil Film-Screen Printing p.68,69
 Step Stakes p.46
 Striping Brushes & Tapes p.44,44A,41
 Styrene-HIPS p.31
 Suction Cups p.40 **T**
 TAPES p.41,66
 Textile Inks-Dyes
 Textile Printers-Dryers
 Transfer Tape-Premask p.10
 Translucent Vinyl p.4
 "Tyvek" p.31
U
 UV SCREEN INK p.56-57
V
 "VELCRO" BRAND TAPES p.15
 VINYL-PLOTTER CUT p.1-9
 Vinyl-Ink jet media p.18-28
W
 WALL MEDIA FILMS p.20,26,27
 Weeding Tool p.12A
 Whi
 Window Perf film p.22
 Wipers-rags p.63
 Wrap Vinyl p.2C, 2D



CC500 GLOSS 3 mil Permanent Opaque Vinyl

A 3mil pressure sensitive polished polymeric flexible calendered vinyl w/permanent adhesive.

This product is recommended for outdoor and indoor uses where a high quality marking film is required, that has flexibility, durability, and resistance to sunlight.

















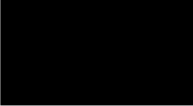











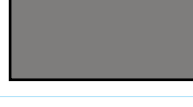



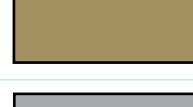

Expected lifetime exterior color fade is 5 yrs. under normal exposure conditions.

This material can be printed with high quality screen printing inks formulated for flexible vinyls.

[Click here](#)

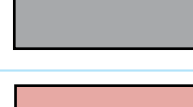
PRICES

WIDTH	1-9 yds.	10 yds.	50yds (ROLL)	WIDTH	1-9 yds.	10 yds.	50yds. (ROLL)
15"perf.	2.75 yd.	2.45 yd.	2.05 yd. 102.50	36"	7.10yd.	6.50 yd.	5.10yd. 255.00
20"	4.05 yd.	3.80yd.	3.30 yd. 165.00	45"	8.65 yd.	8.00 yd.	6.25 yd. 312.50
24"	4.05 yd.	3.80 yd.	3.30 yd. 165.00	48"	10.15yd.	9.55yd.	7.35 yd. 367.50
30"	5.75 yd.	5.40 yd.	4.20 yd. 210.00	60"	11.25 yd.	10.40yd.	7.70 yd. 385.00

 1501 White "BLUE LINER"	 1511 Antique White	 1522 Dark Yellow	 1540 Hot Pink
 1500 Matte White	 1512 Victorian Blue	 1523 Lemon	 1541 Pink
 1502 Black	 1513 Ocean Blue	 1524 Daffodil	 1542 Coral
 1509 Matte Black	 1514 Arctic Blue	 1529 Mint	 1544 Orange
 1503 Transparent	 1515 Sky Blue	 1530 Brown	 1546 Purple
 1504 Matte Clear	 1516 Teal	 1531 Beige	 1548 Plum
 1505 Grey	 1517 Forest Green	 1534 Burgundy	 1549 Lavender
 1506 Midnight Blue	 1518 Dark Green	 1536 Cranberry	 1552 Lilac
 1507 Cobalt Blue	 1519 Green	 1537 Cherry Red	 1550 Gold
 1508 Sapphire Blue	 1520 Kelly Green	 1538 Tomato Red	 1551 Silver
 1510 Vivid Blue	 1521 Lime Green	 1539 Light Red	 1553 Rose Gold



KPMF 2 mil High Performance Cast Film

- Premium 2 mil opaque cast film with permanent acrylic adhesive.
- 8year outdoor durability, designed to meet or exceed OEM Spec.
- Apremium polycoated liner for ease of cutting, weeding, and transfers.
- Excellent conformability enhances adhesion on textured, corrugated, and irregular surfaces with seams or rivets.

[Click here](#)



LONG LIFE APPLICATIONS HIGH PERFORMANCE - 2 mil. GLOSS

PRICE PER YARD

BLACK, WHITE, CLEAR			
WIDTH	1-9 YDS	10 YDS	55 YDS (Roll)
15" Punched	8.70	7.15	5.80
20" Non Punched	11.65	9.75	7.75
24" Non Punched	12.95	11.65	9.10
30" Non Punched	15.55	14.40	11.25
33" Non Punched	17.20	15.35	12.05
36" Non Punched	19.90	17.75	13.60
48" Non Punched	23.35	21.85	16.60
60" Non Punched	31.20	28.35	21.15

COLOURS			
WIDTH	1-9 YDS	10 YDS	55 YDS (Roll)
15" Punched	9.10	8.10	6.40
20" Non Punched	12.95	11.75	9.40
24" Non Punched	14.25	12.50	10.20
30" Non Punched	17.60	15.00	12.25
33" Non Punched	18.70	16.50	13.50
48" Non Punched	25.40	23.65	18.70
60" Non Punched	32.80	29.85	23.60

711 Gloss White	756 - Dark Red	731 - Sunflower Yellow	7620 - Teal	7623 - Brit Blue
7113 Arctic White				
7127 Matte White				
712 - Almond	7519 - Deep Red	7322 - H.O. Lemon	765 - Dark Aqua	7619 -Navy
7112 - Dove Grey	753 - Cardinal Red	774 - Lime Green	776 - Turquoise	7549 -Royal Purple
7116 - Signal Grey	759 - Pillar Box Red	7714 - Light Apple Green	7715 - Light Aqua	7511 -Violet
7111 - Mercury Grey	751 - Tomato Red	7713 - Apple Green	7613 - Light Blue	7614 - Lavender
713 - Light Grey	757 - Mid Red	7731 - Vivid Green	763 - Olympic Blue	7516 -Deep Purple
714 - Medium Grey	744 - Orange Red	771 - Kelly Green	7610 - Intense Blue	7548 - Raspberry
715 - Dark Grey	748 - Dark Orange	7716 - Green	761 - Vivid Blue	7524 -Dark Magenta
7125 - Nimbus Grey	741 - Orange	7730 - Bright Green	766 - Brilliant Blue	7525 - Magenta
721Gloss Black	7310 - Imitation Gold	772 - Forest	764 - Sapphire Blue	787 -Camel
722MatteBlack				
701 Gloss Clear	735 - Melon	775 - Deep Forest	7617 Viking Blue	783 -Brown
706 Matte Clear				
754 - Burgundy	736 - Buttercup	7732 - Traffic Green	7626 - Midnight Blue	781 Chocolate



METALLICS - PREMIUM CAST VINYL

STANDARD METALLICS

KPMF Metallics

Premium 2 mil metallic cast film with permanent acrylic adhesive.
Designed for automotive and architectural design.

Up to 10 yr. outdoor durability.

Contact us for a SMF colour card.

[Click here](#)

Standard Metallics - Prices per yard

WIDTH	1 to 9 yds.	10to 49yds.	55 yds.(roll)
15"	12.00yd.	9.80yd.	7.70yd.
20"	17.70yd.	14.50yd.	10.70yd.
24"	18.30yd.	15.20yd.	11.70yd.
30"	23.10 yd.	18.90yd.	13.80yd.
48"	34.00yd.	27.60yd.	21.15yd.

Metallics

- 7911 Silver
- 7912 Dark Argent
- 7923 Nickel
- 7922 Pewter
- 7924 Light Charcoal
- 7921 Charcoal
- 7931 Bright Gold
- 7934 Light Gold
- 7932 Autumn Gold
- 7933 Dark Gold

Metallics

- 7951 Red
- 7963 Light Blue
- 7964 Mid Blue

Metallics

- 7961 Blue
- 7965 Dark Blue
- 7962 Purple
- 7926 Black

Glitters

SMF's Glitter series is a 4 mil cast "sparkly" vinyl suitable for use in exterior marking and signage applications. It has up to a 10 year outdoor durability. It has been developed by KPMF in the U.K. for Select Marking Films.

This line of vinyl is designed for use in decorative decals and eye catching graphics. It is excellent for use in marine and automotive applications.

Due to variances in computer monitor displays, colours shown are only our best representation. For true colour match, please email or phone for a copy of our SMF colour guide.



75158 - Silver Glitter



75159 - Gold Glitter



75150 - Black Glitter



75151 - Red Glitter



75152 - Pink Glitter



75153 - Forest Green



75155 - Royal Blue Glitter



75156 - Dark Blue Glitter



75157 - Lilac Glitter



75154 - Turquoise Glitter

GLITTER PRICES - per yard

WIDTH	1 to 9 yds.	10 yds.	55 yds. (full roll)
24"	22.35 yd.	18.70 yd.	15.20 yd. 836.00
48"	44.00 yd.	37.40 yd.	29.90 yd. 1644.50

[Click here](#)

NEW PRODUCTS



[Click here](#)

2.6 mil Platinum Calendered Vinyl

SMF's 2.6 mil Platinum Calendered series is manufactured by Ritrama in Italy. This new line is an extremely high quality product suitable for use on smooth, textured and contoured surfaces. SMF films can be used for vehicle lettering to point of sale advertising, from outdoor signage to interior decoration. It is manufactured with a solvent-based adhesive, and mounted on a kraft liner, designed for trouble-free plotter cutting and installations.

804 - Pastel Yellow	806 - Bright Yellow	807 - Sun Yellow	808 - Dark Yellow	810 - Light Orange	811 - Orange
812 - Carrot	814 - Vivid Red	817 - Medium Red	818 - Dark Red	819 - Red	820 - Wine Red
821 - Burgundy	822 - Rioja Red	823 Process Magenta	824 - Plum	826 - Violet	827 - Midnight Blue
829 - Old Blue	830 Dark Blue	833 Ultramarine Blue	834 - Reflex Blue	835 - Cosmos Blue	836-Permanent Blue
837 - Medium Blue	839-Olympic Blue	840 - Light Blue	843 - Dark Lagoon	844 - Forest Green	846 - Freedom Green
848 - Bright Green	849 - Grass Green	850 - Apple Green	851 - Yellow Green	852 - Light Beige	853 Chocolate Brown
801 - Gloss Black	855 - Mystic Grey	857 - Traffic Grey	858 - Dark Grey	860 - Slate Grey	868 - Light Grey
862 - Pearl Grey	800 - Gloss White	899 - Gloss Clear	803 - Matte Black	865 Matte Anthracite Metallic	866 - Matte Silver Metallic
867 - Matte Copper Metallic	802 - Matte White	898 - Matte Clear	<p>Whites and clears have an outdoor durability of up to 10 years The colours have an outdoor durability of up to 8 years Metallic colours have an outdoor durability of up to 5 years</p>		

White Black & Clear	price per yard	15"	24"	48"
	1-9 yards	\$4.90	\$7.40	\$14.75
	10-54 yards	\$4.30	\$6.45	\$12.90
	55- yards (roll)	\$3.10	\$4.60	\$9.25

Colours	price per yard	15"	24"	48"
	1-9 yards	\$5.35	\$8.00	\$16.00
	10-26 yards	\$4.40	\$6.70	\$13.30
	27- yards (roll)	\$3.70	\$5.60	\$11.15

Metallics	price per yard	15"	24"	48"
	1-9 yards	\$6.10	\$9.20	\$18.35
	10-26 yards	\$5.10	\$7.65	\$15.30
	27- yards (roll)	\$4.25	\$6.40	\$12.80

KPMF Metallic Wrap Cast Vinyl with Air Release Liner



KPMF WRAPS & LAMINATES!

KPMF Wraps & Special Effect Laminates - now available from
Graphic Commerce Ltd.



[Click here](#)

KPMF Premium Car Wrapping Films are a range of dual cast PVC films, specifically developed for vehicle wrapping. These films are formulated using the latest advances in chemical and pigment technology to offer exceptional dimensional stability and long term durability. They range in thickness, from 3.3mil to 4.3mil, depending on the colour. These films are also removable, using heat and/or chemicals, up to 3 years after installation from a range of substrates. These films have a life expectancy of 7 to 10 years in vertical applications. *Color Card Available on request*

[application guide](#)

[product data sheet](#)



K75402 - Gloss Atlantic Pearl



K75403 - Gloss Vengeance Red



K75405 - Gloss Indulgent Blue



K75406 - Gloss Momentum Pink



K75407 - Gloss Envious Green



K75409 - Gloss Solar Flash



K75440 - Gloss Magnetic Black



K75441 - Gloss Excelsior Blue

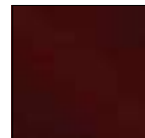

K75447 - Gloss Midnight Crimson Bloom

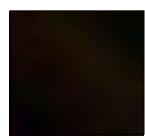

K75448 - Gloss Phantom Black Metallic

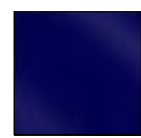

K75452 - Gloss Opulent Indigo



K75468 - Gloss Imperial Orchid



K75501 - Matte Iced Silver Titanium

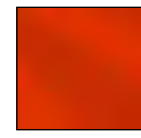

K75502 - Matte Iced Orange Titanium



K75505 - Matte Iced Blue Titanium



K75506 - Matte Iced Red Titanium

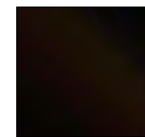

K75528 - Matte Phantom Black



K75534 - Matte Iced Yellow Titanium



K75538 - Matte Sonic Yellow Pearl



K75539 - Matte Siberian Pearl



K75540 - Matte Crystalline White



K75542 - Matte Viper Green



K75543 - Matte Java Brown



K75544 - Matte Trenton Blue



K75545 - Matte Russet Red



K75549 - Matte Anodized Bronze



K75551 - Matte Magnetic Black

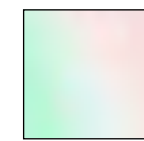

K75552 - Matte Aurora Pearl



K75554 - Matte Autumn Fire



K75560 - Matte Platinum Dark Sage



K75568 - Matte Iced Amethyst Titanium

Frozen Vehicle Wrapping Films

Matte Black in the shade - these frozen films sparkle and shine in vibrant colour when exposed to bright lights or sunshine.



K75573 - Frozen Ruby



K75575 - Frozen Mystic Pink



K75577 - Frozen Emerald

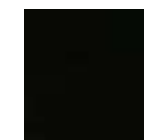

K75578 - Frozen Sapphire

Absolute Matte Wrapping Films

Developed for vehicles that have EXTREME matte finishes



K75801 - Absolute Matte Mythos Red



K75802 - Absolute Matte Quantum Blue



K75803 - Absolute Matte Royal Amethyst

Prices - all items are 60" wide	1-4 yards	5-11 yards	12-24 yards	25 yards
	60.90 yd.	54.60 yd.	46.70 yd.	42.00 yd.

Wrap vinyl & Laminates

KPMF WRAPS & LAMINATES!

KPMF Wraps & Special Effect Laminates, now available from
Graphic Commerce Ltd.



[Click here](#)

Opaque Vehicle Wrapping Films

Airelease Liner - Up to 10 year durability

VWS IV (Vinyl Wrapping System) is a range of premium quality cast PVC films specifically developed for vehicle wrapping. These premium cast products are formulated using the latest advances in chemical and pigment technology to offer exceptional dimensional stability and long term durability. The combination of soft cast vinyl formulation and specific adhesive design offers excellent conformability into recesses, and adhesion which allows the film to be removed using heat and/or chemicals up to a period of three years from a range of substrates (subject to exceptions covered in the warranty).



K75411 - Gloss Chalk White



K75415 - Gloss Ominous Grey



K75531 - Matte Stealth Tundra

Prices	60" Wide
1 to 4 yds.	56.70 yd.
5 to 11 yds.	50.65 yd.
12 to 24 yds.	43.00 yd.
25 yds.	38.85 yd.

[application guide](#)

Starlight & Pearlescent Vehicle Wrapping Films

[Click here](#)

KPMF Starlight & Pearlescent Wrapping Films are a range of dual cast PVC films, specifically developed for vehicle wrapping. These films are formulated using the latest advances in chemical and pigment technology to offer exceptional dimensional stability and long term durability. They range in thickness, from 3.3mil to 4.3mil, depending on the colour. These films are also removable, using heat and/or chemicals, up to 3 years after installation from a range of substrates. These films have a life expectancy of up to 7 years in vertical applications.

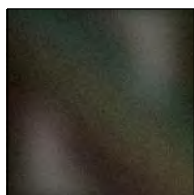

K75470 - Gloss Morpheus Black
[\(Rainbow Starlight Effect\)](#)



K75479 - Gloss Copper/Black Starlight

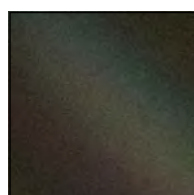

K75571 - Matte Morpheus Black
[\(Rainbow Starlight Effect\)](#)

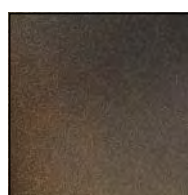

K75579 - Matte Burnished Bronze



K75584 - Matte White/Blue Pearlescent

Prices	60" Wide
1 to 4 yds.	67.70 yd.
5 to 11 yds.	60.90 yd.
12 to 24 yds.	54.60 yd.
25 yds.	49.85 yd.

[Application Guide](#)

Iridescent Vehicle Wrapping Films

KPMF Iridescent Vehicle Wrapping Films are a range of dual cast PVC films, specifically developed for vehicle wrapping. These films are formulated using the latest advances in chemical and pigment technology to offer exceptional dimensional stability and long term durability. They range in thickness, from 3.3mil to 4.3mil, depending on the colour. These films are also removable, using heat and/or chemicals, up to 3 years after installation from a range of substrates. These films have a life expectancy of up to 7 years in vertical applications.



K75408 - Gloss Iridescent Red/Black



K75460 - Gloss Iridescent Green/Black



K75464 - Gloss Iridescent Purple/Green



K75465 - Gloss Iridescent Purple/Black

[Click here](#)

Prices	60" Wide
1 to 4 yds.	67.70 yd.
5 to 11 yds.	60.90 yd.
12 to 24 yds.	54.60 yd.
25 yds.	49.85 yd.

[Application Guide](#)



K75466 - Gloss Iridescent Purple/Blue



K75469 - Gloss Iridescent Blue/Black



K75565 - Matte Iridescent Purple/Black



K75566 - Matte Iridescent Purple/Blue

Wrap vinyl & Laminates

KPMF WRAPS & LAMINATES!

KPMF Wraps & Special Effect Laminates, now available from Graphic Commerce Ltd.



[Click here](#)

K80000 Hybrid Car Wrapping

[application guide](#)

KPMF Hybrid Wraps are superior quality soft Polymeric PVC films formulated by using the latest advances in PVC and pigment technology to offer exceptional dimensional stability and excellent long-term durability. They are suitable for long term applications in outdoor and indoor environments, offering excellent cutting and weeding properties. The combination of soft vinyl formulation and specific Airelease adhesive design offers excellent conformability and adhesion which allows the film to be removed without leaving adhesive transfer. Typical applications include total vehicle cover, vehicle graphics, signs and decal applications which require exterior exposure of 5 to 7 years. The material is designed to be removable, under controlled conditions, up to a period of three years.



K88021 - Gloss Black - 60" wide



K88011 - Gloss White - 60" wide.



K89021 - Matte Black - 60"wide

Hybrid Pricing 60" wide material

Product No.	1-9 yds.	10-26 yds.	27 yds.
K88021 Gloss Black	30.95yd	25.00yd	22.00yd
K88011 Gloss White	29.75yd	24.50yd	21.00yd
K89021 Matte Black	32.25yd	26.50yd	23.00yd

K87021 CARBON FIBRE BLACK



60" wide sold

by the foot

1 to 9 ft. - 25.85 foot
10 to 49 ft. - 18.80 foot.
50 ft. - 14.45 foot.

[Click here for photo examples product data,](#)

K88025 Ultimate Hi Gloss Black Roof Wrap 60" width

[click for photos, specs, data, applic.](#)



Ultimate Black is a high gloss self-healing black vinyl which is ideal for accents during wrapping. It installs like a PPF product using a wet application method because there is no air egress liner. The material can stretch slightly, but is not designed to wrap an entire vehicle. It is perfect for roofs, small accents and especially chrome deletes. The special coating allows it to have an unrivalled high gloss finish that will self heal from small scratches and maintain it's true black look for years.

PRICES - 60" Width - 1 to 4 yds.-68.00 yd. 5 to 9 yds.- 59.85 yd. 10 yd. Roll-56.70 yd.

[Click here](#)

K71000 Special Effect Laminates - 60" Width

[spec. sheet](#)

These films represent a luxury and innovative over-laminate that transform any application with the creation of a sparkling starlight or pearlescent appearance. These high quality 2 mil cast over-laminating films have been specially developed for use in the vehicle wrap and digital imaging industry to permanently enhance and protect wrap & print media. They offer a premium solution to over-laminating applications by using a solvent-base acrylic adhesive system.

Color Card Available on request

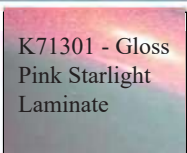

K71301 - Gloss Pink Starlight Laminate

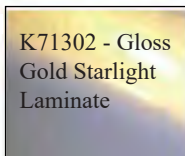

K71302 - Gloss Gold Starlight Laminate



K71303 - Gloss Pacific Blue Starlight Laminate



K71304 - Gloss Rainbow Starlight Laminate



K71306 - Gloss Silver Starlight Laminate

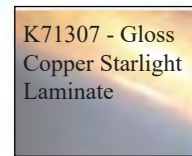

K71307 - Gloss Copper Starlight Laminate

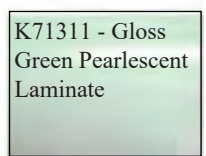

K71311 - Gloss Green Pearlescent Laminate

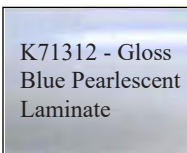

K71312 - Gloss Blue Pearlescent Laminate

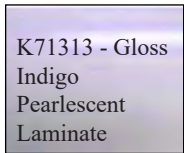

K71313 - Gloss Indigo Pearlescent Laminate

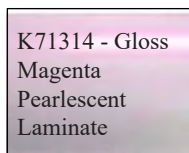

K71314 - Gloss Magenta Pearlescent Laminate



K71401 - Matte Pink Starlight Laminate

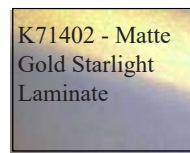

K71402 - Matte Gold Starlight Laminate



K71403 - Matte Pacific Blue Starlight Laminate

Prices	60" Wide
1 to 4 yds.	56.70 yd.
5 to 11 yds.	50.60 yd.
12 to 24 yds.	43.00yd.
25 yds.	38.85 yd.

[Click here](#)

Magnets for Vehicle Wraps Extra Strong



9.00 each

[Click here](#)



Knifeless Tapes

[Click here for prices, Video, and Descriptions](#)

[Click here](#)



AVERY



SC 950 Super Cast Film

Now with one more year of durability, choose from 112 high performance industry standard colors including 19 matched to PANTONE standards. (Formerly SC900 Series)

SC 950 OPAQUE

CONFORMABILITY: rivets/corrugations, compound curves
PRINTABILITY: CAS, thermal transfer
GLOSS: 90
ADHESIVE: permanent
TYPE: cast Vinyl

Long life applications

High performance - 2 mil. Gloss

Features enhanced shelf life and best-of-class weeding

[Click here for Color Chart for SC 950 opaque series](#)

[Click here](#)

GLOSS WHITE AND GLOSS BLACK

PRICE PER YARD			
WIDTH	1-9 YDS	10-49 YDS	50 YDS
15" Punched	9.90	8.35	7.30
24" Non Punched	14.00	12.40	11.40
30" Non Punched	17.55	15.75	14.20
48" Non Punched	25.90	24.75	22.75

COLOURS PLUS CLEARS AND MATTE WHITE AND MATTE BLACK

PRICE PER YARD			
WIDTH	1-9 YDS	10-49 YDS	50 YDS
15" Punched	10.15	9.70	8.40
24" Non Punched	14.60	14.15	13.75
30" Non Punched	19.85	18.35	16.00
48" Non Punched	32.80	29.90	25.85



AVERY

SC950 METALLIC SERIES

Metallic unrivaled selection of 32 colours to choose from.
High gloss premium quality metallic cast film.
DURABILITY 5-7 years
CONFORMABILITY rivet/corrugations, compound curves
PRINTABILITY CAS, thermal transfer
ADHESIVE permanent solvent
GLOSS 90
TYPE cast vinyl

[Click here](#)

SC950 METALLIC SERIES

WIDTH	PRICE PER YARD	1 - 9 YDS	10-49 YDS	50 YDS
15"punched	click here for	15.65	14.10	12.60
24" non-punched	metallic chart	24.60	22.75	20.00
48" non punched		49.40	43.45	40.15

SC950 ULTRA METALLIC SERIES

WIDTH	PRICE PER YARD	1 - 9 YDS	10-49 YDS	50 YDS
15" punched	click here for	22.30	20.15	18.15
24" non-punched	metallic chart	35.40	31.95	28.45
48" non-punched		70.85	63.25	56.35



AVERY

HP 750 Opaque Series

The industry benchmark in intermediate signage, with unparalleled cutting and weeding.



Durability 6-years
Conformability flat simple curves
Printability CAS thermal transfer
Adhesive permanent solvent
Gloss 70
Type calendered vinyl

Width	10-49 yds.	50 yds.
15"p	3.55	3.10
24"	5.45	4.55
30"	6.60	5.75
48"	10.50	9.25

Note: min. order on HP 750 series is 10 yds.

(Formerly HP 700 Opaque Series)

[click here for HP 750 opaque color card](#)

[Click here](#)



AVERY

UC 900 Translucent Series

Indoor and outdoor illuminated signs that prove a premium look day and night for a variety of applications. Broadest color palette in the industry for color confidence.

[Click here](#)

Durability up to 9 years
Conformability flat simple curves, compound curves.
Printability CAS thermal transfer, thermal forming
Adhesive permanent solvent
Gloss 30
Type cast vinyl

Width	1-49 yds.	50 yds.
15"p	14.50 yd.	12.20yd.
24"	22.90	18.35
30"	28.30	22.95
48"	43.70	36.55

Consistent color under both transmitted and reflected lighting conditions



[click here for UC 900 color card](#)

SMF 4mil Matte Calendered Fluorescent Vinyl

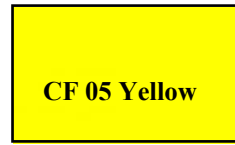

Used to produce promotional and safety graphics accented with a high level of decorative visibility. Designed for short-term applications with up to 6 months exterior exposure based on vertical applications and amount of UV exposure.



SMF Calendered fluorescent Vinyl - per yard				
WIDTH	1 to 9 yds.	10 yds.	55 yds.	(full roll)
24"	17.50 yd.	14.00 yd.	11.40 yd.	627.00
48"	32.80 yd.	27.25 yd.	22.00 yd.	1210.00

[Click here](#)

SMF GLOSS CAST FLUORESCENT 2 MIL GLOSS VINYL

With up to 2 yr. outdoor durability it is one of the longest lasting fluorescent films in the world. Used to produce promotional and safety graphics accented with a high level of decorative visibility.



SMF Cast fluorescent Gloss Vinyl - per yard				
WIDTH	1 to 9 yds.	10 yds.	55 yds.	(full roll)
24"	25.50 yd.	21.20 yd.	16.80 yd.	924.00
48"	49.85 yd.	41.50 yd.	32.55 yd.	1790.25

[Click here](#)

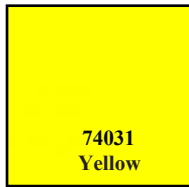
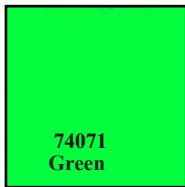

SMF 3.4 mil Premium Calendered Translucent Vinyl

SMF's Translucent series is a 3.4mil premium calendered vinyl suitable for use in all types of backlit signage applications. The vinyl is extremely conformable which makes it suitable for use on smooth, textured and contoured surfaces. All colours have up to a 5 year durability, with many having a durability of up to 7 years.

TRANSLUCENT COLOUR LIST

600 White Translucent	606 Light Yellow	612 Bright Yellow	610 Yellow	620 Orange	629 Light Red	627 Medium Red
630 Red	689 Magenta	652 Dark Purple	645 Brown	658 Olympic Blue	650 Blue	653 Dark Blue
640 Violet	667 Light Green	670 Green	683 Forest Green	604 Light Grey	605 Dark Grey	601 Black Translucent
673 Grass Green new	679 Lime Green new	674 Meadow Green new	677 Turquoise new	678 Cyan new	680 Signal Blue new	675 Ultra Marine new
671 Silver new	672 Gold new	676 Bordeaux new				

SMF Translucent Calendered Vinyl - per yard				
WIDTH	1 to 9 yds.	10 yds.	55 yds.	(full roll)
24"	13.15 yd.	10.95 yd.	9.45 yd.	519.75
48"	25.00 yd.	21.45 yd.	18.00 yd.	990.00

[Click here](#)



WINDOW GLASS ETCH

[Click here](#)



790 Light

791 Deep

FROSTED/ETCH GLASS



ETCH GLASS

see color card

GF- ETCH #790 Light Etch - #791 Deep Etch

3.0 mil Polymeric vinyl - up to 7 yr. durability

Width	1-9yds.	10yds.	50yds.
Price Per yard	Price Per yard	Price Per yard	Price Per yard
24"	12.35	11.35	10.15
30"	15.50	14.50	12.70
48"	22.50	21.50	19.65
60"	26.95	25.95	23.95

SMF BRAND - 2 mil CAST VINYL GLASS ETCH

11500 Frosted Etch- 11507 Etch Glass Green- up to 10 yr. durability

Width	1-9yds.	10yds.	55yds.
Price Per yard			
24"	18.90	15.60	12.40
36"	30.25	25.70	19.85
48"	37.40	29.40	23.60
60" (11500 only)	47.60	37.80	31.50

SMF BRAND - 2.8 mil Calendered Vinyl Glass Etch

15011 Silver - 15012 Textured Silver - 15031 Gold - up to 7 yr. ext.

Width	1-9yds.		10yds.		55yds.	
	Silver	Gold Text. Silver	Silver	Gold Text. Silver	Silver	Gold Text. Silver
Price Per yard						
24"	15.75	16.80	12.60	13.00	10.30	10.65
36"	23.85	26.00	18.90	21.50	12.60	15.75
48"	28.35	29.40	22.85	24.30	18.40	19.95
60"	36.20	n/a	28.00	n/a	24.55	n/a

SMF BRAND "CRYSTAL" Glass Etch - 2mil Cast Vinyl

UP TO 12 YR. EXTERIOR DURABILITY

Numbers 11512 Crystal Silk & 11513 Crystal Sparkle

Width	1-9yds.		10yds.		55yds.	
	Silk	Sparkle	Silk	Sparkle	Silk	Sparkle
Price Per yard						
24"	20.40	35.15	17.00	26.00	13.65	21.50
36"	35.15	55.55	29.40	44.10	22.65	34.00
48"	39.70	62.35	32.85	52.10	26.00	40.75
60"	52.10	n/a	44.10	n/a	32.85	n/a

790AE NEW

PRINT-n-PRIVACY



Print-n-Privacy

3.0 mil - Polymeric Glass Etch Film (Light)
Clear Solvent Permanent Adhesive
90# Paper Air Egress Liner
(Dry Apply Only)

7 yr / -

Rolls only

790AE-54 54"x75' 570.00 1.69sq.ft.



Printable w/Solvent, Latex or UV



SMF 3 MIL CALENDERED TRANSPARENT FILM

[Click here](#)

These Transparent coloured vinyls are designed for backlit signage, window graphics and colour change overlaminating use. While not optically clear, they are designed for glass decorations and light boxes. The film is a monomeric calendered vinyl with a gloss finish. They come with a liner that offers superior cuttability with conventional die-cutting and computer sign making systems.

3 to 5 yr. outdoor durability based on normal exterior conditions.



SMF Calendered Transparent Vinyl - per yard

WIDTH	1 to 9 yds.	10 yds.	55 yds.	(full roll)
24"	9.90yd.	8.20yd.	6.95 yd.	382.25
48"	18.65 yd.	15.75 yd.	13.45 yd.	739.75

Special Effect Film 24" wide

[Click here](#) 

SMF's Special Effect Film line is a line of metalized vinyl films. These films print beautifully when using thermal transfer ribbons, screen inks, or solvent/eco-solvent inks. These Special Effect Films have an outdoor durability of up to 5 years.

Due to variances in computer monitor displays, colours shown are only our best representation.

For true colour match, please email or phone for a copy of our SMF colour guide.

Digital Print Film

PRICES: ALL COLORS

1-9 yds. - 36.75 yd.	10yds.-31.50 yd.	Roll-50yds - 1260.00
----------------------	------------------	----------------------

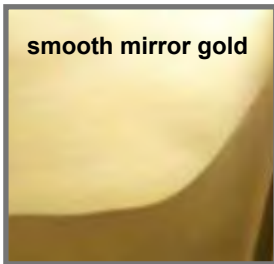

smooth mirror gold

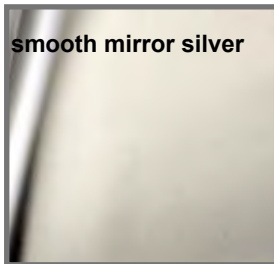

smooth mirror silver



Brushed gold



Brushed silver



Diamond Plate silver

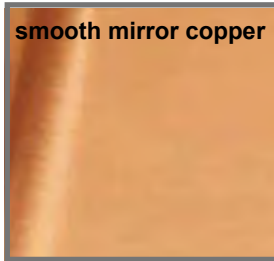

smooth mirror copper



Brushed copper

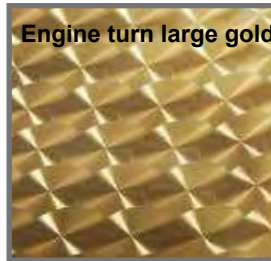

Engine turn large gold



Florentine gold



Hammered gold



Coarse Brushed gold



Coarse Brushed silver

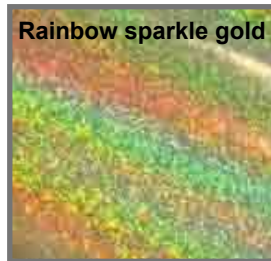

Rainbow sparkle gold



Rainbow sparkle silver



Rainbow sequins silver



Rainbow brite gold



Rainbow brite silver



Rainbow brite pink

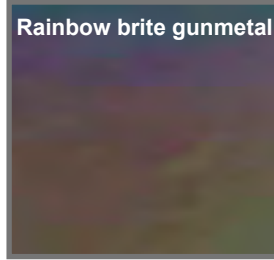

Rainbow brite gunmetal



Carbon fibre gunmetal

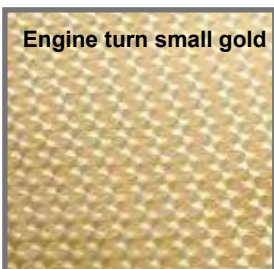

Engine turn small gold



Florentine silver

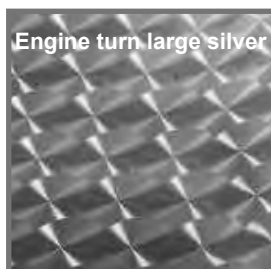

Engine turn large silver

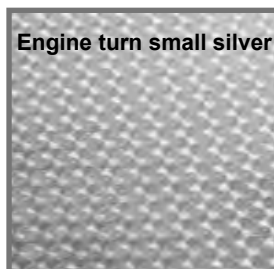

Engine turn small silver

All films are 2.7mil calendered vinyl

Up to 5 yr. outdoor durability

Color card with swatches available on request.

METALLIZED POLYESTERS



METALLIZED POLYESTERS

Custom films with the brilliance and lustre of true metal foils and the handling and workability of vinyl. These films are designed to accept a variety of solvent and u/v screen inks. Pre-testing is recommended. Good for indoor and short term outdoor applications. A high tack premask is recommended.

[Click here](#)

metallized polyesters price per yard price per yard			
SMF - 1-1/2 MIL - BRT. SILVER - BRT. GOLD - BRUSHED SILVER #2070 #1076 #2072			
WIDTH	1-9 YDS	10 YDS	50 YDS
15" Punched	8.75	7.00	5.60
20" Non Punched	12.00	10.30	8.35
24" Non Punched	13.45	11.20	8.85
30" Non Punched	17.60	14.00	11.00
48" Non Punched	25.95	20.80	16.80
54" Non Punched	28.35	22.55	18.70



#2070
Bright Silver

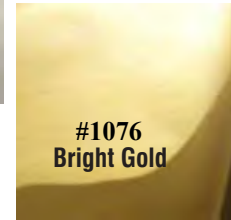

#1076
Bright Gold



#2072
Brushed Silver

metallized polyesters #1072 SMF 2 MIL BRUSHED GOLD POLYESTER price per yard			
WIDTH	1-9 YDS	10 YDS	50 YDS
15" Punched	9.20	7.35	6.00
20" Non Punched	13.90	11.00	9.00
24" Non Punched	14.65	11.75	9.45
30" Punched or Non Punched	18.35	15.10	11.85
48" Non Punched	28.35	22.55	18.10
54" Non Punched	31.35	24.40	19.60

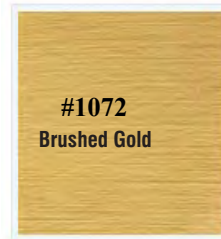

#1072
Brushed Gold

[Click here](#)

HOLOGRAPHIC PRISMATIC FILM A METALLIZED light diffraction material depicting colours of the spectrum. 2.4 mil polyester. AVAILABLE IN: • SPARKLE #2016 • RAINBOW			
HOLOGRAPHIC PRISMATIC PRICE PER YARD			
WIDTH	1-9 YDS	10 YDS	50 YDS
15" Punched	12.90	10.40	8.40
20" Non Punched	18.70	15.25	12.35
24" Non Punched	19.85	16.00	13.10
30" Punched or Non Punched	24.65	20.25	16.40
48" Non Punched	36.15	30.95	24.85



[Click here](#)

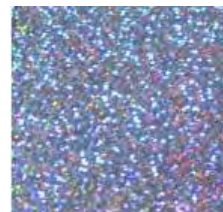

#2016
Prismatic Sparkle



Prismatic Rainbow

Features and uses:

- Easy to cut and weed.
- Vehicle markings.
- Very flexible and can be applied over rivets and corrugated surfaces.

5700 is a flexible reflective film (Engineering Grade) providing wide-angle reflectivity of incident light and giving excellent night and day visibility. The face is made with a layer of microscopic glass beads of a high optical quality. These are embedded into a colored film, which then act as a lens. A metallized back provides the mirrored surface for reflection. The film is coated with a white, high strength, permanent, acrylic adhesive. A 92# white polycoated paper liner offers stability and excellent layflat qualities.

[Click here for spec sheet including Product Description and Suggested Printing Methods](#)



PRICE PER YARD			
WIDTH	1-9 YDS	10 YDS	50 YDS (Roll)
White - 24"	27.75	25.95	23.50 (1175.00)
White - 48"	53.90	48.50	44.50 (2225.00)
Colors- 24"	32.75	30.95	27.95 (1397.50)
Colors- 48"	64.50	61.90	44.50 (2225.00)

Scotchlite™ 3M

3M # 3200 ENGINEERING GRADE - 7 YEAR - PERFORATED - INTERIOR/ EXTERIOR APPLICATION - 3200 Engineering reflective vinyl is manufactured for use on flat surfaces such as sign boards and directional signage. It is not recommended for vehicular graphics.

3290 White



[Click here](#)

PRICE PER YARD			
WIDTH	1-9 YDS	10 YDS	50 YDS (Roll)
White - 24"	22.70	20.70	19.00 (950.00)

New!! 3M 7300 Reflective Series Engineer Grade

[Click here](#)

Better Reflectivity at a lower price. Yes, you read that right!
Offers greater visibility day or night.
Brighter commercial signs and traffic control signs, means graphics printed on white will draw even more attention
Available in White and Orange



impact resistant



Flexible for simple curve applications (not transportation) grade.
Digitally printable. Compatible with screen, latex, UV, and solvent based inks.

Prices for White

Sold in 24" and 48" widths. Prices for White only			
24" wide	1-9yds. 19.25yd.	10-49yds 17.30yd.	50yds-768.90
48" wide	1-9yds. 39.40yd.	10-49yds 37.20yd.	50yds-1362.90

Prices for Orange

Sold in 24" and 48" widths. Prices for Orange only			
24" wide	1-9yds. 24.75yd.	10-49yds 20.70yd.	50yds-768.90
48" wide	1-9yds. 39.40yd.	10-49yds 37.20yd.	50yds-1362.90



KIWA REFLECTIVE - TRANSPORTATION GRADE

- Fleet grade 5.5 mil premium cast reflective film
- 7 year outdoor durability meets OEM specs.
- Formulated for computer cut applications
- Designed for flat, corrugated, and irregular surfaces including rivets, with superior conforming characteristics
- Excellent results in screen and thermal printing applications

COLOURS: 17013 White 17033 Lemon Yellow 17043 Yellow 17053 Orange



17063 Red 17163 Dark Red 17183 Lt. Blue 17083 Blue 17073 Green 17093 Black 176154 Gold



PRICE PER YARD			
WIDTH	1-9 YDS	10 YDS	50 YDS
15" Punched	26.25	20.90	17.65
20" Non Punched	38.60	31.90	25.20
24" Non Punched	40.75	33.00	28.00
30" Non Punched	51.80	38.60	34.00
48" Non Punched	76.00	63.95	51.75

[Click here](#)

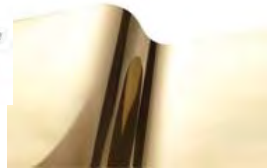

smooth chrome gold

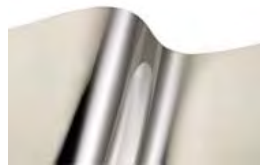

smooth chrome silver

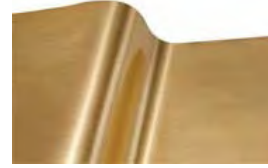

brushed gold

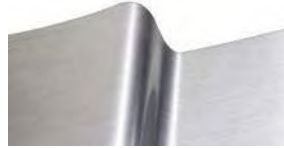

brushed silver



diamond plate silver

Outdoor Durability - up to 3 years

Our VinylEfx® Outdoor Durable Series, which provides up to three years of outdoor life, is comprised of a variety of cost-effective simulated metal, light-diffracting and 3-D patterns, designed for long-term outdoor signage. For demanding applications such as truck and boat graphics, the VinylEfx® Durable Series films provide a superior alternative to the expensive simulated gold-leaf films.

RTape VinylEfx® is exceptionally suited for general purpose signage applications and a cut above other “special effects” films thanks to a proprietary deep-embossing technology that provides a crisper three-dimensional appearance to each pattern. **Because the VinylEfx® is vinyl, not polyester, they require no top coating prior to printing!** They print, cut, weed and handle just like intermediate vinyl.

[click here to view color card, full specs, application guide, and tech information](#)

Vinyl Efx - Outdoor	24" WIDE			48" WIDE
	1-9 yds. per yd.	10 yd. roll	50 yd. roll	50 yd. rolls only
Smooth Chrome Silver	23.95	219.00	935.00	1797.00
Smooth Chrome Gold	26.95	235.00	1058.00	2030.00
Brushed Silver	26.95	235.00	1058.00	2030.00
Brushed Gold	31.00	275.00	1244.00	2390.00
Diamond Plate Silver	26.95	235.00	1058.00	2030.00



Print compatability:
solvent - eco-solvent,
latex,
uv inkjet,
screen printing



DRY ERASE FILMS - Luminescent Film

Carbon Fibre Black Film - Conspicuity Film

DRY ERASE FILM



Write / on wipe/off clear pressure sensitive overlaminates
Designed for use with dry erase markers
Recommended for flat applications



Clear Laminate

G/F BRAND - DRY ERASE FILM #111 Clear - price per yd.				
WIDTH	1-9 YDS	10 YDS	50 YDS	
54" only	9.60yd.	8.50yd.	6.78yd. (roll 339.00)	

SMF BRAND - DRY ERASE FILM - price per yard				
WIDTH		1-9 YDS	10 YDS	50 YDS
15" Punched		3.75	2.75	2.20
24" Non-Punched		6.15	4.70	3.55
30" Non-Punched		7.40	5.60	4.35
48" Non-Punched		12.95	9.75	7.50
60" Non-Punched		14.95	11.00	8.50

G/F BRAND - ERASE MARK PRO #110 Clear - price per yd.
Size 54"x50 yd. rolls only - 719.00 roll

2 mil Commercial Grade Dry Erase Laminate
Engineered for ong-term dry erase applications
Resistant to permanent & semi-permanent markers
5 year indoor durability with proper care & cleaning
For use in hospitals, Restaurants, Retail & Schools



Luminescent Film



premium cast vinyl
5mil - up to 10 year
exterior exposure

Luminescent Film



premium cast vinyl
5mil - up to 10 year
exterior exposure



Priced per **FOOT**
White or Yellow

Width	24"	48"
1-9 feet	23.60	43.30
10 feet	21.10	38.35
50+feet	17.35	32.90

This premium quality cast vinyl is designed for use in all emergency sign and marking applications. It has the ultimate properties for outdoor graphic or emergency equipment and exit signs.

1 Hour Luminosity Life after exposure to artificial or outdoor light

The vinyl is very conformable and can be used on smooth, textured, and contoured surfaces. Printable by digital and screen process

CARBON FIBRE BLACK



6 mil calendared vinyl film with a clear re-positionable permanent acrylic adhesive on an air-egress liner.

60" WIDTH	
1-9 ft..	- 25.85 foot
10-49 ft.	- 17.80 foot
50 ft.	- 14.45 foot

CONSPICUITY TAPE

- Compliant with Specification NHTSA 49 CFR/ part 571/DOT C-2
- 2" WR7-11 stripe (7" white/11" red)



PRICE PER YARD			
WIDTH	1-9 YDS	10 YDS	50 YDS
2"	10.00	8.70	6.30



Sure-Cut™ Plotter Blade Series

Target Plotters	Configuration	Angle	Part #	Description	List Price
<ul style="list-style-type: none"> Gerber III/IV, S/750 Sprint Series Lettersmith GS15 Plus Anagraph Excel 1/1m Compugraphicarty 		30° 45° 60°	SC-1030 SC-1045 SC-1060	SC-1000 Carbide Series Our unique design enhancement reduces blade drag and improves cutting of small characters and graphics on standard pressure-sensitive materials. For best results, use the following recommended blade angles when cutting these material thicknesses: 30° 2-4 mil / 45° 4-12 mil / 60° 12 mil+.	30.59
<ul style="list-style-type: none"> Gerber III/IV, S/750 Sprint Series Lettersmith Anagraph Excel 1/1m Compugraphicarty 		30° 45° 60°	G-30 G-45 G-60	Standard Gerber Configuration Carbide G-Series Limited to cutting 1/2" letters and up. For best results, use the following recommended blade angles when cutting these material thicknesses: 30° 2-4 mil / 45° 4-12 mil / 60° 12 mil+.	26.25
<ul style="list-style-type: none"> All Roland Allen Datagraph 936/800 CSR Ecom-2 Anagraph - EMS Vinyl Express Lynx Panther 		30° 45° 60°	SC-1330 SC-1345 SC-1360	SC-1300 Carbide Series SC-1345 is the substitute for Roland PRC 145-01 blades. For best results, use the following recommended blade angles when cutting these material thicknesses: 30° 2-4 mil / 45° 4-12 mil / 60° 12 mil+ with an offset of .015.	59.75
<ul style="list-style-type: none"> Ioline Studio 7/8 Artpro Series / Super 88 / Smartrac (small blade) Techno-Arts Switchblades Classic K-Cad-RBL-C 		30° 45° 60°	SC-1430 SC-1445 SC-1460	SC-1400 Carbide Series Substitute for Ioline PN 103233. For best results, use the following recommended blade angles when cutting these material thicknesses: 30° 2-4 mil / 45° 4-12 mil / 60° 12 mil+.	43.20
<ul style="list-style-type: none"> American Graphtec Cutting Pro / FC-Series Nova Cut 		45° 60°	SC-1945 SC-1960	SC-1900 Carbide Series Similar to CB-09U blade offered by plotter manufacturer, except GAP blade tips have the advantage of being constructed out of carbide, not steel! Carbide tipped blades offer much better durability and longer performance. For best results, use the following recommended blade angles when cutting these material thicknesses: 45° 2-6 mil / 60° 6 mil+ with an offset of .018	53.90
<ul style="list-style-type: none"> Mimaki CG-Series New Star DGI Omega 		37° 40° 56°	SC-2037 (Type 1) SC-2040 (Type 3) SC-2056 (Type 5)	SC-2000 Carbide Series For best results, use GAP SC-2037 (Type 1-round tip blade) on 2-4 mil material thicknesses, with .25-.30 offset setting. Use GAP SC-2040 (Type 3-beveled edge blade) on 2-4 mil for cutting small letters and detail, with .125 offset setting. Use GAP SC-2056 (Type 5-round tip blade) on materials 4 mil and up, with .29 offset setting.	61.00

Sure-Cut™ Plotter Blade Series



Target Plotters	Configuration	Angle	Part #	Description	List Price
<ul style="list-style-type: none"> Gerber GSX, GXX-Plus, HS Swivel 		42° 60°	SC-2742 SC-2760	SC-2700 Carbide Blade Series Substitute for Gerber P44985B blade. For best results, use the following recommended blade angles when cutting these material thicknesses: 42° 2-6 mil / 60° 6 mil+.	71.00
<ul style="list-style-type: none"> All Roland Allen Datagraph 936 / 800 CSR Ecom-2 		45°	SC-2945	SC-2945 Carbide Blade Substitute for Roland ZEC-U1001 blade. Designed for cutting very small lettering and graphics. For best results, use for cutting on 2-6 mil materials.	72.00
<ul style="list-style-type: none"> Summagraphics T-Series (Insert Blade Holder) 		36° 60°	SC-3036 SC-3060	SC-3000 Carbide Series SC-3036 is the substitute for Summagraphics 390-549 blade. SC-3060 is the substitute for Summagraphics 390-550 blade. For best results, use the following recommended blade angles when cutting these material thicknesses: 36° 2-12 mil / 60° 12 mil+.	51.50
<ul style="list-style-type: none"> American Graphtec (New Holder) 		45° 60°	SC-3245 SC-3260	SC-3200 Carbide Series Substitute for American Graphtec CB-15U. Designed for thick materials. For best results, use the following recommended blade angles when cutting these material thicknesses: 35° 2-12 mil / 60° 12 mil +.	79.50
<ul style="list-style-type: none"> Summagraphics D-Series GRI 		35° 60°	SC-3335 SC-3360	SC-3300 Carbide Series Substitute for Summagraphics 391-360. For best results, use the following recommended blade angles when cutting these material thicknesses: 35° 2-12 mil / 60° 12 mil+ with an offset of .017.	42.30
<ul style="list-style-type: none"> Mutoh XP-Series Gerber Emboss Track, Odyssey P-Cut 630 Creation 		30° 45° 60°	SC-3830 SC-3845 SC-3860	SC-3800 Carbide Series Substitutes for the Mutoh 300936 30°, 300937 45° and 300938 60° blades. For best results, use the following recommended blade angles when cutting these material thicknesses: 30° 2-4 mil / 45° 4-12 mil / 60° 12 mil+.	61.00
<ul style="list-style-type: none"> Mutoh SC-Series Gerber Fast Track 		30° 45° 60°	SC-4130 SC-4145 SC-4160	SC-4100 Carbide Series Substitute for Gerber P61639A with brass collar. For best results, use the following recommended blade angles when cutting these material thicknesses: 30° 2-6 mil / 45° 6-12 mil / 60° 12 mil+.	53.00
<ul style="list-style-type: none"> Envision SP-1500 		30° 45° 60°	SC-4530 SC-4545 SC-4560	SC-4500 Carbide Series For best results, use the following recommended blade angles when cutting these material thicknesses: 30° 2-4 mil / 45° 4-12 mil / 60° 12 mil+.	61.00



Premask Transfer Tapes & Paint Mask

SERIES 4075 RLA- 100 yard rolls



R Tape Conform Series® application tapes and premasks with RLA® Release Liner Adhesion lay flat and stick to slick release liners to resist tunnelling, wrinkling & edge curl, even when graphics are rolled.

- All Purpose application tape for the majority of signmaking applications
- Most popular application tape available
- Small and Medium size plotter and die cut lettering and graphics

SIZE	PRICE
1 1/4"	9.40
2 1/4"	17.10
3 1/4"	24.85
4 1/4"	32.00
6 1/2"	48.60
8 1/2"	63.00
10 1/2"	77.00
12"	88.00

SIZE	PRICE
14"	101.00
16"	119.00
18"	134.00
20"	145.00
24"	177.00
30"	215.00
36"	267.00
48"	349.00



SERIES 4050 APLI-TAPE - 100 yard

SIZE	PRICE
24"	119.00
30"	149.00
48"	237.00
54"	267.00

A medium- tack paper application tape, R Tape 4050 allows easier release of larger graphics and those with high gloss levels, and is also suitable for lifting printed graphics without the risk of damaging the print. Works well in wet applications. Economically priced. Has the same features of the Conform series but without the RLA Conform release liner adhesion additive



AT-60 CLEAR

Clear Application Tape 100 yd. roll

AT-60 Clear Choice is an economical, ultra-clear application film which is priced as an alternative to standard grade application paper. AT-60 Clear Choice features a slightly tackier adhesive, which facilitates the transferring of problematic vinyl films. The new adhesive system is very forgiving. If adhesive touches adhesive, the Clear Choice film pulls apart easily, with no adhesive delamination.

SIZE	PRICE
12"	86.00
14"	105.00
24"	169.00
30"	227.00
48"	349.00



MACmark®

Paint Mask - Grey

Price per yard



Specialty grey transparent vinyl film designed for paint mask applications. The adhesive is ultra removable and the product is designed for easy cutting on all brands of plotters. Product removes cleanly from most substrates.

WIDTH	1-9 YDS	10 YDS	55 YDS	(Roll)
24"	4.35	4.00	3.67	201.85
30"	5.50	5.00	4.38	241.00
48"	7.65	7.00	6.71	369.00
60"	----	----	8.29	456.00

Paint Mask (Stencil Mask) - white or yellow



WHITE PAINT MASK - PRICES

A specially formulated PVC facestock with removable adhesive. Used for stencilling on flat or curved surfaces. Excellent for removable vinyl letters. Available in white or yellow

YELLOW PAINT MASK - PRICES

WIDTH	1 to 24 YDS.	25 YDS.	50 YDS. (ROLL)
24"	5.15per yd	4.60 per yd.	4.34yd. 217.00
48"	9.95 per yd.	9.50 per yd.	8.86 yd. 443.00

WIDTH	1 to 24 YDS.	25 YDS.	50 YDS. (ROLL)
24"	5.15per yd.	4.60 per yd.	4.34yd. 217.00
48"	9.95 per yd.	9.50 per yd.	8.86yd. 443.00

APPLICATION FLUIDS- ADHESIVE REMOVERS



RAPID TAC OR RAPID TAC II

For "wet" applications • Rapid Tac II for other than Premium Vinyls.



STEP 1

1. Thoroughly clean panels with Rapid Tac and kitchen paper towel. Do not use other cleaners or solvents nor cloth towels or commercial paper towels.



STEP 2

2. Spray panels again with Rapid Tac. Peel backing off decal and place on wet panel. You may also spray adhesive side of decal (See fig. 3)



STEP 3

3. Align decal. Use the squeegee to remove fluid, using a good deal of pressure and working from the center out toward the edges in all directions. (See fig. 3)



STEP 4

4. Wait 2-3 minutes. If decal has cover tape saturate it with Rapid Tac, then remove the tape. Wipe with paper towel and your application is complete. (See fig. 4)

110822



[click here for demonstrations](#)

RAPIDTAC APPLICATION FLUID is a "super-wet" liquid which cleans the substrate surface and makes the application of even the largest of pressure sensitive markings simple, allowing the correct positioning before final placement.



32oz. with sprayer - 17.55
128 oz. (gallon) without sprayer - 48.75

RAPIDTAC APPLICATION FLUID II

RAPID TAC APPLICATION FLUID II - has the same benefits as RAPIDTAC, but also allows wet application of polyesters, reflectives, and metallized films. Improves bonding on economy type vinyls

32 oz. with sprayer - 22.95
128 oz. w/o sprayer - 66.95



RAPIDTAC ADHESIVE REMOVER

RAPIDTAC WATER SOLUBLE ADHESIVE REMOVER removes glue left on surface after removing decals or film. Works on painted surfaces, some plastics and other surfaces. Not recommended for anodized finishes.

32 oz. with sprayer - 39.50
128oz (gal.)w/o sprayer-107.00

Remove most adhesives in 30 to 60 seconds!
Scoop off adhesive in 60 seconds like shovelling snow!



RAPIDPREP

RAPID Prep is a water-based nonflammable wash solvent for preparing surfaces for painting. Totally removes silicone, wax, grease, and oil safely. Especially useful on plastic auto parts.

32 oz. with sprayer - 17.70
128 oz. w/o sprayer - 51.00



RAPID CLEAR

Cleans and polishes any transparent material eg. glass, Lexan, Plexiglass, most Polycarbonates, and leaves a professional lustre. Also does an excellent job on non transparent surfaces.

Use as a final cleaning for sign work.
32 oz. w/sprayer - 15.25
128 oz. w/o sprayer 41.00



RAPID REMOVER Adhesive remover, works in 60 seconds.



STEP 1

1. Remove decal with heat lamp or heat gun.



STEP 2

2. Now spray glue residue with Rapid Remover and let it penetrate for 30-60 seconds.



STEP 3

3. Using squeegee, scrape to remove glue residue.



STEP 4

4. Now spray Rapid Remover on rag or paper towel and wipe area clean.
5. Thoroughly rinse area with Rapid Tac or Rapid Tac II

RECOMMENDATION:

DO NOT clean any substrate with glass cleaners, paint solvents, (prep-sol, pre-cleto, etc.). Just clean substrate with: Rapid Tac Application Fluid, Rapid Tac II Application Fluid, or for stubborn jobs like silicone, wax, grease or oil, clean with Rapid Prep. All 3 products were built to clean leaving no contaminating residue.

DO USE kitchen type paper towels and Rapid Tac products to clean prior to application of vinyl or films ONLY!

Graphic Commerce Ltd.

SQUEEGEE APPLICATORS FOR VINYL INSTALLATIONS

Saves time !

Saves money !

Saves Fatigue !

Assures a better application !

"Easy Glide" SQUEEGEE 5"



w/soft felt pad on one side and
teflon strip on the other. 5.95 ea.

Same 5" Squeegee without the felt
and teflon - 2.10 ea.



MACTAC FELT
4" - 5.95



3M GOLD 4" 6.75 ea.



RC6 - Blue 6" Squeegee
6" - 3.85 ea.

BIG BLADE INDIGO
-FLEXIBLE 3" x 4" 1.49 ea.



Removes graphics,
preventing scratches.
Double edged Flexible
Chemically resistant.



GC 4" (w/built in ruler) 4"-
1.15 each

Wide Format Squeegees - 12"wide



RC12- White 12" Squeegee - 6.25 ea.

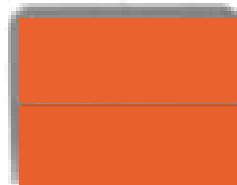

SIGNCAL - 3.5"
ORANGE
1 SIDED - .69 ea.



5.9" Yellow Teflon Hard
Card Squeegee
4.50 ea.

APPLICATOR TOOLS FOR VINYL - CONTINUED.

Excel Hook-on Weeding Tool w/cap
detaches adhesive materials from surfaces
13.75 ea.



cushion grip for comfort

Excel Weeding Tool w/cap - Awl needle Point
used for weeding and vinyl bubble air release
6.30 ea.



Excel Weeding Tool w/cap and 4 extra blades



9.95 ea.

Replacement needles only for Excel
needle point weeder.

Pkg. of 5 - 4.95



Excel Tweezers



For accurate control in sorting, probing, and
precision work. Needle sharp - Light tension.
Surgical steel.



Curved Point Tweezers - 6" - 7.70 ea.



Sharp Point Tweezers - 4 3/4" - 7.70 ea.



RIVET BRUSH

Size 1-1/2"-12.75

A stiff-bristled nylon brush is
used to burnish vinyl film onto
the heads of truck rivets, curves
and large textured areas.



1.49 ea.

Lift-Stick Adhesive Remover

This product is red in color and used to aid in the lifting of pressure
sensitive material and the removal of adhesive from surfaces. If used
correctly, it will not scratch the substrate. It is made of a special aircraft
plastic that makes it very durable. The 6" length is designed to prevent
hand fatigue when used continually during big jobs.

**Speedball®
SOFT BRAYERS**

Made from pure gum natural rubber with a ground
finish. 20 durometer hardness. Heavy duty steel
frame. Package contains craft tip usage guide.

**Speedball®
HARD BRAYERS**

Hard rubber roller made from synthetic
rubber (80 durometer). Available in 4 inch
width only.

**Speedball®
ACRYLIC BRAYER**

4" Clear Acrylic Brayer Roller is
interchangeable in a 1 piece sturdy
plastic frame.



Deluxe
model soft



soft

**WITH STURDY 1 PIECE
PLASTIC FRAME FOR
POP-IN REPLACEABLE
ROLLERS**

#4117 - 4" w/ roller 20.60 ea.
#4187 - 4" roller only 15.95



Deluxe model
hard

WITH METAL FRAME

#4121 - 4" - 22.50 ea.



hard

**WITH PLASTIC 1 PIECE
FRAME FOR POP-IN
REPLACEMENT
ROLLERS**

#4128 - 4" w/roller - 15.65ea.
#4186 - 4" roller only 9.45ea



hard

WITH PLASTIC 1 PIECE FRAME

#41234- 4" acrylic brayer - 28.80 ea.
#4184 - 4" acrylic roller only-18.40ea.



Magnets for Vehicle Wraps

Extra - Strong

for easy positioning of vehicle graphics
during installation.

9.00 ea.



Replacement Ink Jet Cartridges

for "Roland" Eco and "Mimaki" Eco and "Mimaki" SS21 Solvent Ink jet Printers



440 ml. cartridge size:

Available in:
Black
Cyan
Magenta
Yellow

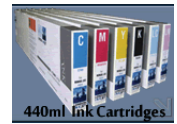

Ink-mate compatible cartridges by "Alphachem" one of the world's leaders in reliable ink-jet technology. Satisfaction assured. 440 ml. cartridge size

Price: - 115.00 ea.

CARTRIDGES

SANDBLAST

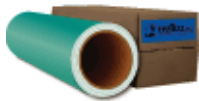

SANDBLAST Stencil

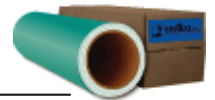

Hartco All Purpose Application

SANDBLAST STENCIL

Sandblast Stencil 400 series - 25 mil

A sandblast resistant material used for sandblasting wood (raw or painted), glass, polyurethane foam, fiberglass, and other similar substrates. Air pressure limits - up to 90psi (80 psi on large grits)





width	per yard	10 yd. roll	width	per yard	10 yd. roll
15"	23.75	160.65	30"	45.15	312.90
20"	31.50	212.10	48"	71.40	472.50
24"	36.20	251.75	60"	89.25	600.60

IMAGE EDGE

Image Edge™ Trim An enhancing and protective cap for mounted graphics.

Range of glossy and metallic finishes. Permanently bonds to rigid substrates

Edges are mitered and glued to back of mounting. Image Edge Trim Machine available on request.

Image Edge Lineals			Sold in lengths of 8 ft. each	
PROFILES	PART# / COLOR	Price per 8 ft. length		
 3/16" (5mm)	041014 Chrome	5.80 ea.	 1/2" (12mm)	011014 Chrome
	041100 Gold			011100 Gold
	041013 Black			011013 Black
	041023 White			011023 White
	041018 Red			011018 Red
	041027 Blue			011027 Blue
	041020 Matte Black			011020 Matte Black
 13/16" (22mm)	036014 Chrome	11.95 ea.	 13/16" (22mm)	036014 Chrome
	036100 Gold			036100 Gold
	036013 Black			036013 Black
	036023 White			036023 White
	036020 Matte Black			036020 Matte Black

Also available in 1/8", 5/32", 1/4", and 3/8" in gloss black, gloss white, chrome & gold.

Prices

1/8" - 4.00 ea.
5/32" - 4.95 ea.
1/4" - 5.95 ea.
3/8" - 8.50 ea.

CORNER ROUNDER

LASSCO Cornerrounders®

Standard Cutting Unit Diagram

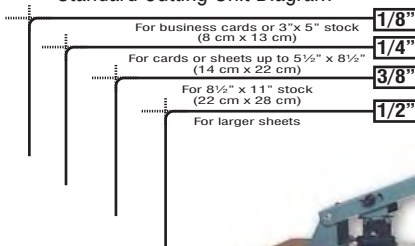

Desktop Heavy Duty Cornerrounder® 757.00

CR-50B Heavy Duty Bench Model Cornerrounder® designed with smooth rigid cutting action for hard-to-do jobs. Accepts full range of interchangeable cutting units (1/16" to 1/2" radii) with a maximum cutting depth of 1/2". One standard cutting unit (1/8", 1/4", 3/8", or 1/2") included.



Desktop Cornerrounders®

Model 20 \$439.00

The Model 20 Desk Top Cornerrounder® handles up to 1/2" (13mm) of stock per cut. Equipped with your choice of one cutting unit: 1/8", 1/4", 3/8" or 1/2". The table leaf extends to accommodate 8-1/2" x 11" or larger sheets.

* Capacity of cutting unit is dependent on material being cut and radius of being used.

Cutting Units and Attachments

Standard sizes - 1/8", 1/4", 3/8" 1/2"	237.00
Special sizes - 1/16", 3/32", 3/16", 5/16"	307.00
Large radius - 3/4", 1", 1 1/2"	419.00



VELCRO® BRAND HOOK AND LOOP FASTENING TAPES

The answer to temporary application of signs on POP displays. Tapes have an adhesive backing and are easily adhered to corrugated plastic, acrylic, styrene and others smooth surfaces.

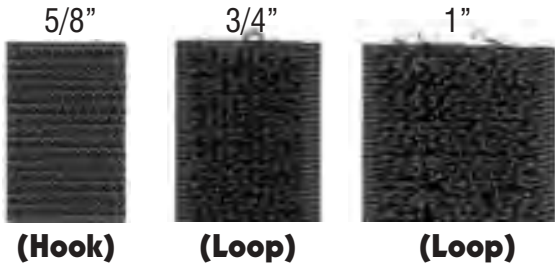

- **Hook Tape:**
 - Woven nylon base with 8 mil nylon monofilament hooks.
 - 330 hooks per square inch.
- **Loop Tape:**
 - Woven nylon base with nylon napped loops.



SPECIAL PRICES



PRICES		25 YARD ROLL	
		Hook or Loop	Hook and Loop
5/8" Velcro	White or Black	17.50	35.00
3/4" Velcro	White or Black	19.90	39.80
1" Velcro	White or Black	26.80	53.60



w/ Metal Hook .53 ea.
1 3/4" diameter clear plastic
1-99 .53 each
100 - less 10%
1000- less 15%

Suction Cups

Ideal for adhering signs to windows



w/ Thumb Tack .31 ea.
1 3/4" diameter clear plastic
1-99 .31 each
100 - less 10%
1000- less 15%

MAGNETIC SHEETING

Magnetic sheeting is great for automotive, truck signs, bulletin and game boards. The sheeting cuts easily with a knife, scissors or dies.
FOR BUSINESS: Advertise your company on a sign that can be permanent or easily removed from your vehicle.

[click here for a detailed sheet on clean and care guidelines](#)

Thickness	Type	Rolls - 24"x50 ft.	Cut Pieces
.030	Matte White	219.00	4.70 per lin. foot
.030	Gloss White	219.00	4.70 " " "
.030	P/S Adhesive	219.00	4.70 " " "
.030	Magnet only	183.00	4.25 " " "
.020	Matte White	183.00	4.25 " " "
.020	Gloss White	183.00	4.25 " " "
.020	P/S Adhesive	183.00	4.25 " " "
.020	Magnet only	136.00	3.25 " " "
.015	Matte White	165.00	3.75 " " "
.015	Gloss White	165.00	3.75 " " "
.015	P/S Adhesive	165.00	3.75 " " "

24" WIDE MAGNETIC VINYL



see printing specs



New!! High Energy Magnetic Sheeting .030ga.
Stronger holding power than normal 40 mil magnets.
Gloss White - Both sides magnetic - 24" width
Prices: Roll 24"x45ft.-259.00 Cut pieces 24"wide - 6.95 lineal ft.
[click here for more info and specs.](#)

Now Available! Magnetic Rolls in extra wide 48" width
.030 Matte White - 48"x 30 ft. long - (rolls only) - 349.00
.020 Matte White - 48"x 30 ft. long - (rolls only) - 269.00

Magnetic Vinyl Tape .060
w/3M #9448 PSA adhesive back

1/2" x 100 ft. roll	29.00
1" x 100 ft. roll	56.00
1/2" x 100 ft. roll w/grooves - (type A)	29.00



Magnetic **BIZ-CARD MAGNETS** Just peel and stick to any regular 2"x 3.5" business card **only 19.00** per pkg. of 100

High Energy -Magnetic Vinyl Tape - **High Energy**

.060 w/ 3M #9448 PSA adhesive back

3/4" x100 ft. roll - 49.50 per roll



VELCRO® BRAND

Suction Cups

MAGNETIC SHEETING

Note- All of the following products are available by phone or email only. Shopping Cart not in effect for these items.



Pressure Sensitive Vinyl Decal Sheet & Roll Stock

Printability: Note- These vinyl sheets and rolls are printable with screen printing vinyl inks or UV cured screen printing inks.



90lb. layflat liner



MATTE

MATTE

GLOSS

MATTE

STATIC

Decal Stock		Sheets			Adhesive - Description	
MATTE VINYL - 3.4 mil		SHEETS 27" X 38"				
DESCRIPTION	ADHESIVE	PRICE PER SHEET				
		1-99	100	250		
MATTE WHITE VINYL - PERM. ADHESIVE Non Top Coated - VFW-NTC-AP/90#		3.45	2.90	2.60	Permanent	
MATTE WHITE VINYL - REMOV. ADHESIVE Non Top Coated - VFW-NTC-AR/90#		3.45	2.90	2.60	Removable	
MATTE WHITE VINYL - LOW TACK REMOV. Non Top Coated - VFW-NTC-ARLT/90#		4.20	3.65	3.35	Low Tack	
MATTE WHITE VINYL- BLOCKOUT PERM. ADHES. Non Top Coated - VFW-NTC-OAP/90#.		4.90	4.25	3.85	Blockout	
MATTE WHITE VINYL HIGH TACK PERM.ADHES. Non Top Coated - VFW-NTC-HTAP/90		4.70	3.90	3.65	Hi-Tack	
MATTE CLEAR VINYL - PERM. ADHESIVE Non Top Coated - VFMC-NTC-AP/90		4.50	3.80	3.60	Clear Vinyl	
MATTE COLOR VINYL - PERM. ADHESIVE Colors - Yellow - Deep Yellow - Black - Red Non Top Coated - VFY/DY/R/B/NTC-AP/90#		5.20	4.50	4.15	Color Vinyl	54" X 50 YDS 485.00

GLOSS VINYL - 3.4 mil		SHEETS 27" X 38"				
DESCRIPTION	ADHESIVE	PRICE PER SHEET				
		1-99	100	250		
GLOSS WHITE VINYL - PERM. ADHESIVE Non Top Coated - VFGW-NTC-AP/90		4.35	3.65	3.45	Gloss Perm.	
GLOSS WHITE VINYL - LOW TACK REMOV. Non Top Coated -VFGW-NTC-ARLT/90 GLOSS		4.35	3.65	3.45	Gloss Remov.	
CLEAR VINYL - PERM. ADHESIVE Non Top Coated - VFC-NTC-AP/90		4.35	3.65	3.45	Clear Perm.	
GLOSS CLEAR VINYL - LOW TACK REMOV. Non Top Coated - VFC-NTC-ARLT/90		4.00	3.45	3.05	Gloss Low Tack	

VALUE VINYL - 3.2 mil		SHEETS 27" X 38"				
DESCRIPTION -All the same features as the 3.4mil matte above but with a price reduction for 3.2mil		PRICE PER SHEET			Economy Vinyl	
		1-99	100	250		
MATTE WHITE VINYL - PERM. ADHESIVE Non Top Coated - VFWM-NTC-AP/90#		2.85	2.40	2.15	White Perm.	
MATTE WHITE VINYL- LOW TACK REMOV. Non Top Coated - VFWM-NTC-ARLT/90#		3.10	2.60	2.40	White Low Tack	

STATIC VINYL General Formulations 7 mil Static Cling Vinyl						
SHEETS 27" X 38" -10 pt. Liner			ROLL 54"x75 ft. - 90# liner		Static Cling White & Clear	
PRICE PER SHEET clear or white			PRICE PER ROLL			
1-149	150	300	clear	white		
3.95	3.20	2.90	191.00	196.00		

Gloss Clear or Gloss White sheets have a 10 pt printable lay-flat release liner. Rolls have a 90# lay flat release liner. G/F Static Vinyls are UV and Solvent Ink Jet printable. Also screen printable with GP series. Not recommended for lettering or screening with enamels. Test prior to using.

Note- All of the following products are available by phone or email only. Shopping Cart not in effect for these items.



PRESSURE SENSITIVE POLYESTER (MYLAR)

Sheet size 20" x 27" - Rolls 27" x 50 yards

TOP COATED - PERMANENT ADHESIVE - 90# STAY FLAT LINER

	SHEETS (20" x 27") (Price per sheet)				ROLLS - 27" X 50 Yards Price per roll		CUT PIECES per yard price	
	1-99	100	250	500	(1)	(4)	27" width	
CLEAR POLYESTER CODE NO.							1 to 9 yds.	10 to 49 yds.
2 mil. CLEAR C2-STC-AP/90	2.20	2.00	1.85	1.75	180.00	164.00	4.35 yd.	4.10 yd.
SILVER (CHROME) POLYESTER								
2 mil. BRIGHT SILVER S2-STC-AP/90	2.70	2.45	2.25	2.10	225.00	197.00	5.65 yd.	5.05 yd.
2 mil. MATTE SILVER MS2-TC-AP/90	4.35	4.10	3.95	3.60	330.00	315.00	7.80 yd.	6.95 yd.
GOLD POLYESTER								
2 mil. BRIGHT GOLD G2-STC-AP/90	5.30	4.95	4.70	4.45	390.00	366.00	9.25 yd.	8.15 yd.
WHITE POLYESTER								
2 mil. WHITE POLYESTER W2-STC-AP/90	3.60	3.25	3.10	2.80	273.00	247.00	6.70yd.	6.00 yd.
BRUSHED POLYESTER								
2 mil. BRUSHED SILVER - BS2-STC-AP/90	3.90	3.70	3.60	3.20	325.00	297.00	7.80 yd.	6.75yd.
2 mil. BRUSHED GOLD - BG2-STC-AP/90	5.75	5.35	5.20	4.85	408.00	390.00	9.55 yd.	8.40 yd.

SOLID ALUMINUM FOIL

2 mil gloss silver hard foil - sheet size 20" x 27" Top Coated - Permanent Adhesive 90 lb. Sta Flat Liner.

Price per Sheet - 13.75 per sheet

TAMPER PROOF MYLAR

1.5 mil Bright Silver Polyester
Will destruct in a void pattern
Top Coated - Permanent Adhesive

sheet size - 20"x27"	1-24 sheets- 12.55 sheet
	25-99 sheets- 11.45 sheet
	100 sheets - 10.85 sheet

DESTRUCTIBLE WHITE VINYL

2mil White Destructible Vinyl 27" x 38" non top coated - permanent adhesive - lay flat liner

sheet size - 27"x 38"	- 12.30 sheet



CLEAR CALENDERED OVERLAMINATE

This 3 mil calendered overlaminate film has been specifically developed for digital printing. Coated with a solvent based permanent pressure sensitive adhesive, it is particularly suitable for indoor, outdoor signs, exhibition displays, window graphics, POP displays, steel rule and thermal diecut. The moisture stable liner also provides excellent lay-flat qualities.

Available in clear gloss and matte clear and lustre clear. Up to 5 yr. outdoor durability under normal exposure conditions.

3 mil Matte/Lustre/Gloss - up to 5 yr. exterior	50 Yards	24"	30"	36"	48"	54"	60"	
	25 to 49 Yards	3.25	4.10	5.20	6.65	7.40	8.20	
	10 to 24 Yards	4.05	5.10	6.45	8.25	9.15	10.15	
		5.20	6.45	8.20	10.45	11.60	12.90	



CLEAR POLYESTER OVERLAMINATES

1 mil CLEAR Polyester Overlaminate (Matte) Indoor	50 Yards	18"	36"	50"	54"		
	25 to 49 Yards	3.00	5.80	6.10	6.40		
	10 to 24 Yards	3.80	7.60	8.00	8.30		
		5.10	10.10	10.60	11.10		
2 mil CLEAR Polyester Overlaminate (Glossy) Indoor	50 Yards	18"	27"	36"	50"	54"	60"
	25 to 49 Yards	3.15	3.50	6.10	6.70	7.05	7.65
	10 to 24 Yards	3.85	4.05	6.75	7.05	7.60	8.20
		4.15	4.50	8.20	8.50	9.10	10.10

Digital Print Media

Eco-Solvent, Solvent, Latex & UV Curable Inkjet Printers

MATTE WHITES

MATTE WHITES

SERIES	PRODUCT DESCRIPTION	DURABILITY / REMOVABILITY	PART #	SIZE	ROLL PRICE	per sq. ft.	ADHESIVE / INK TYPE
201	3.4 mil - Matte White Vinyl Clear Permanent Adhesive 90# Layflat Liner	5 yr / -	201-54	54"x150'	323.00	.47	
			201-60	60"x150'	367.00	.49	
201-HTAP	3.4 mil - Matte White Vinyl Clear High-Tack Permanent Adhesive 90# Layflat Liner	5 yr / -	201-HTAP-54	54"x150'	374.00	.55	
			201-HTAP-60	60"x150'	416.00	.63	
201-HTAPAE	3.4 mil - Matte White Vinyl Clear High-Tack Permanent Adhesive 90# Air Egress Layflat Liner	5 yr / -	201-HTAPAE-54	54"x150'	423.00	.63	
201-OAP	3.4 mil - Matte White Opaque Vinyl Grey Permanent Adhesive 90# Layflat Liner	5 yr / -	201-OAP-54	54"x150'	331.00	.49	
			201-OAP-60	60"x150'	369.00	.49	
201OPAE NEW	3.4 mil - Matte White Opaque Vinyl Grey Solvent Permanent Adhesive 90# Air Egress Layflat Liner	5 yr / -	201OPAE-54	54"x150'	419.00	.63	
202	3.4 mil - Matte White Vinyl Clear Low-Tack Removable Adhesive 90# Layflat Liner	5 yr / 1 yr	202-54	54"x150'	342.00	.51	
			202-60	60"x150'	389.00	.52	
214	3.2 mil - Matte White Promotional Vinyl Clear Permanent Adhesive 70# Layflat Liner	3 yr / -	214-54	54"x150'	273.00	.41	
			214-60	60"x150'	302.00	.39	
222	6.0 mil - Matte White Semi-Rigid Vinyl Clear Permanent Adhesive 90# Tight Release Liner	3 yr / -	222-54	54"x100'	308.00	.68	
223	6.0 mil - Matte White Semi-Rigid Vinyl Clear Low-Tack Removable Adhesive 90# Tight Release Liner	3 yr / 1 yr	223-54	54"x100'	314.00	.70	
			223-60	60"x100'	350.00	.71	

GLOSS WHITES

GLOSS WHITES





















203	3.0 mil - Gloss White Vinyl Clear Permanent Adhesive 90# Layflat Liner	5 yr / -	203-54	54"x150'	321.00	.48	
			203-60	60"x150'	357.00	.48	
203-OAP	3.0 mil - Gloss White Opaque Vinyl Grey Permanent Adhesive 90# Layflat Liner	5 yr / -	203-OAP-54	54"x150'	331.00	.49	
203OPAE NEW	3.0 mil - Gloss White Opaque Vinyl Grey Solvent Permanent Adhesive 90# Air Egress Layflat Liner	5 yr / -	203OPAE-54	54"x150'	419.00	.63	
204	3.0 mil - Gloss White Vinyl Clear Low-Tack Removable Adhesive 90# Layflat Liner	5 yr / 1 yr	204-54	54"x150'	335.00	.50	
216	3.2 mil - Gloss White Promotional Vinyl Clear Permanent Adhesive 70# Layflat Liner	3 yr / -	216-54	54"x150'	273.00	.41	
			216-60	60"x150'	302.00	.40	
218	WindowMark™ Blockout 8.0 mil - Gloss White Dual-Layer Blockout Vinyl Clear Removable Adhesive 90# Layflat Liner	3 yr / 1 yr	218-54	54"x100'	490.00	1.09	
220	6.0 mil - Gloss White Semi-Rigid Vinyl Clear Permanent Adhesive 90# Tight Release Liner	3 yr / -	220-54	54"x100'	324.00	.72	
			220-60	60"x100'	359.00	.60	
221	6.0 mil - Gloss White Semi-Rigid Vinyl Clear Low-Tack Removable Adhesive 90# Tight Release Liner	3 yr / 1 yr	221-54	54"x100'	324.00	.72	
			221-60	60"x100'	359.00	.60	
203-HTAP NEW	3.0 mil - Gloss White Vinyl Clear High-Tack Permanent Adhesive 90# Layflat Liner	5 yr /	203HTAP-54	54"x150'	374.00	.55	
203-HTAPAE NEW	3.0 mil - Gloss White Vinyl Clear High-Tack Permanent Adhesive 90# Air Egress Layflat Liner	5 yr /	203HTAPAE-54	54"x150'	423.00	.63	
246	2.4 mil - Gloss White Premium Vinyl Grey Solvent Permanent Repositionable Adhesive 90# Layflat Liner	7 yr / 2 yr	246-54	54"x150'	625.00	.87	

NOTE: All durability statements are estimates based on unprinted media and deemed to be reliable; however, this information is given without a guarantee and does not constitute a written warranty. Please refer to the specific product bulletins for further information at www.generalformulations.com.

Digital Print Media for Eco-Solvent, Solvent, Latex & UV Curable Inkjet Printers









GLOSS CLEARS

GLOSS CLEARS

SERIES	PRODUCT DESCRIPTION	DURABILITY / REMOVABILITY	PART #	SIZE	ROLL PRICE	per sq. ft.	ADHESIVE / INK TYPE
205	3.0 mil - Gloss Clear Vinyl Clear Permanent Adhesive 90# Layflat Liner	3 yr / 1 yr	205-54	54"x150'	347.00	.51	   
			205-60	60"x150'	394.00	.52	
206	3.0 mil - Gloss Clear Vinyl Clear Low-Tack Removable Adhesive 90# Layflat Liner	3 yr / 1 yr	206-54	54"x150'	355.00	.52	   
			206-60	60"x150'	399.00	.53	
219	6.0 mil - Gloss Clear Semi-Rigid Vinyl Clear Low-Tack Removable Adhesive 90# Tight Release Liner	3 yr / 1 yr	219-54	54"x100'	323.00	.71	   
255	3.0 mil - Optically Clear Gloss Vinyl Optically Clear Solvent Removable Adhesive 2.0 mil Traction Backed Polyester Liner	3 yr / 1 yr	255-54	54"x150'	547.00	.94	   
247	New Face Film Print-n-Lam 3.0 mil - Clear Gloss UV Polymeric Vinyl - 7 yr Clear Permanent Adhesive 90# Layflat Liner		247-54	54"x150'	424.00	.63	   









MATTE CLEAR

MATTE CLEARS

248	New Face Film Print-n-Lam 3.0 mil - Matte Clear UV Polymeric Vinyl - 7 yr Clear Permanent Adhesive 90# Layflat Liner		248-54	54"x150'	424.00	.63	   
287	ROUGHMark RoughMark Clear 3.5 mil - Matte Clear Polymeric Conformable Wall Vinyl Clear Solvent High-Tack Removable Adhesive 90# Layflat Liner <i>(If Laminate is desired, Concept 242 Gloss Laminate is recommended)</i>	5 yr / 6 mo	287-5475	54" x 75"	438.00	1.29	   
			287-54	54"x150'	829.00	1.23	









TRANSIT

TRANSIT FILMS

209	MetroMark 3.5 mil - Matte White Opaque Transit Vinyl Clear Removable Adhesive 90# Layflat Printed Logo Liner	5 yr / 1 yr	209-54	54"x150'	385.00	.56	   
209AE	OUTFRONT <i>Approved</i> 209AE-w/Air Engress liner		209-60	64"x150'	454.00	.56	
275	SubMark 3.5 mil - Matte White Opaque Transit Vinyl Clear High-Tack Adhesive 90# Layflat Printed Logo Liner OUTFRONT <i>Approved</i> TITAN <i>Approved</i>	5 yr / -	275-54	54"x150'	642.00	.95	   
228	TransMark 6.0 mil - Matte White Translucent Vinyl Clear Solvent Removable Adhesive 90# Layflat Liner	3 yr / 1 yr	228-54	54"x100'	679.00	1.51	   
277	MetroGrafix Window Meta 4.0 mil - Matte White Opaque Vinyl - 5 yr Clear Removable Solvent Adhesive 90# Layflat "MetroGrafix Logo" Liner For Bus and Train Applications.(Body Tall) Combines with GF101 Lustre Laminate		277-54	54"x150'	624.00	.92	   

TRANSLUCENTS



















TRANSLUCENTS

224	TransMark 3.2 mil - Matte White Translucent Vinyl Clear Solvent Permanent Adhesive 90# Layflat Liner	5 yr / -	224-54	54"x150'	823.00	1.21	   
228	TransMark 6.0 mil - Matte White Translucent Vinyl Clear Solvent Removable Adhesive 90# Layflat Liner VERIFONEMEDIA <i>Taxi Top Approved</i>	3 yr / 1 yr	228-54	54"x100'	679.00	1.51	   

Digital Print Media for Eco-Solvent, Solvent, Latex & UV Curable Inkjet Printers





























FLOOR & CARPET (indoor only)

FLOOR & CARPET (indoor only)

SERIES	PRODUCT DESCRIPTION	DURABILITY / REMOVABILITY	PART #	SIZE	ROLL PRICE	per sq. ft.	ADHESIVE / INK TYPE
**210	 Traffic Graffiti 3.4 mil - Matte White "Floor Advertising" Vinyl Clear Removable Adhesive 90# Layflat Liner	5 yr / 6 mo	210-54	54"x150'	395.00	.59	   
			210-60	60"x150'	449.00	.59	
**212	 Traffic Graffiti 3.4 mil - Matte White "Carpet Advertising" Vinyl Clear High-Tack Removable Adhesive 90# Layflat Liner	5 yr / 6 mo	212-54	54"x150'	417.00	.61	   
*211	 Traffic Graffiti 6.0 mil - Gloss Clear Laminate Clear Permanent Adhesive 53# Liner	- / -	211-54	54"x150'	571.00	.85	
			1 to 9 yds. 14.30 yd. 10yds.-13.00 yd.				
*109	 Traffic Graffiti 5.0 mil - Scratch Resistant Textured PVC Laminate Clear Permanent Adhesive 1.5 mil Clear Polyester Liner	- / -	109-38	38"x150'	566.00	1.19	
			109-54	54"x150'	628.00	.93	
			1 to 9 yds. 14.15 yd. 10yds.-12.95 yd.				
*213	 Traffic Graffiti 3.75 mil - Embossed Clear Polypropylene Laminate Clear Permanent Adhesive 53# Liner <i>Indirect Food Contact Solution - The film and adhesive complies with the following citations in 21CFR 174 thru 182 and 21CFR 175.105 respectively</i>	- / -	213-54	54"x150'	394.00	.59	
*217	 Traffic Graffiti 3.0 mil - Gloss Clear PVC Laminate Clear Permanent Adhesive 53# Liner	- / -	217-54	54"x150'	391.00	.58	
*UL	TRAFFIC GRAFFITI CLASSIFIED BY UNDERWRITERS LABORATORIES, INC. AS TO SLIP RESISTANCE ONLY UL410 **DURABILITY AND REMOVABILITY SPECIFICATIONS ARE CONTINGENT UPON USING TRAFFIC GRAFFITI MATCHED COMPONENT SYSTEM (CONCEPT BASE MEDIA & CONCEPT UL RATED LAMINATE)						











WALLS (indoor only)

WALLS (indoor only)

226 & 226HTR	 WallMark 6.0 mil - Matte White Semi-Rigid Wall Vinyl Clear Low-Tack Microsphere Beaded Adhesive 90# Tight Release Liner 226 HTR has High Tack Removable Adhesive	5yr / 1 yr	226-54	54"x100'	419.00	.93	   
			226-54HTR	54"x100'	448.00	1.00	
229 & 229HTR	 WallMark Canvas 6.0 mil - Matte White Embossed Canvas Wall Vinyl Clear Low-Tack Microsphere Beaded Adhesive 90# Tight Release Liner (ASTM E84 Class 1) 229HTR has High tack Removable Adhesive	5yr / 1 yr	229-54	54"x100'	522.00	1.16	   
			229-54HTR	54"x100'	604.00	1.35	
234	 GraphiTex 7.0 mil - Matte White Polyester Wall Fabric Clear Low-Tack Wall Adhesive 90# Layflat Liner	5 yr / 1 yr	234-54	54"x100'	717.00	1.59	   
253	 GraphiTex Opaque (99% opaque) 6.0 mil - Matte White Opaque Polyester Wall Fabric Clear Re-Positionable Wall Adhesive 90# Layflat Liner. Clean removable from most surfaces for 1 yr.	10yr/ 1 yr	253-54	54"x100'	782.00	1.74	   
290 NEW	 ChalkMark 5 mil - Black Chalkboard Vinyl Clear Solvent High-Tack Removable Adhesive 90# Layflat Liner * UV curable ink only	5 yr / 1 yr	290-4875	48"x75'	449.00	1.51	 
250	 WallFrog 4.0 mil - Matte White Polyester Wall Fabric Clear Low-Tack Wall Adhesive 90# Layflat Liner	5 yr / 1 yr	250-54	54"x100'	589.00	1.31	   
Part Roll Price - 54" Wide only 1-9 yds. -21.20 yd. 10-33 yds.-19.30 yd.							

WALLS

(indoor/outdoor)

285 NEW	 RoughMark 3.5 mil - Matte White Polymeric Conformable Wall Vinyl Clear Solvent High-Tack Removable Adhesive 5 yr / 6 mo 90# Layflat Liner (If Laminate is desired, Concept 242 Gloss Laminate is recommended)	5 yr / 6 mo	285-5475	54"x 75'	438.00	1.30	   
			285-54	54"x150'	829.00	1.23	
287 NEW	 RoughMark Clear 3.5 mil - Matte Clear Polymeric Conformable Wall Vinyl Clear Solvent High-Tack Removable Adhesive 90# Layflat Liner (If Laminate is desired, Concept 242 Gloss Laminate is recommended)	5 yr / 6 mo	287-5475	54"x75'	438.00	1.30	   
			287-54	54"x150'	829.00	1.23	

p.20

WALLS (indoor/outdoor)

Digital Print Media for Eco-Solvent, Solvent, Latex & UV Curable Inkjet Printers

WINDOWS

SERIES	PRODUCT DESCRIPTION	DURABILITY / REMOVABILITY	PART #	SIZE	ROLL PRICE	per sq. ft.	ADHESIVE / INK TYPE
202	3.4 mil - Matte White Vinyl Clear Low-Tack Removable Adhesive 90# Layflat Liner	5 yr / 1 yr	202-54	54"x150'	342.00	.51	
			202-60	60"x150'	389.00	.52	
204	3.0 mil - Gloss White Vinyl Clear Low-Tack Removable Adhesive 90# Layflat Liner	5 yr / 1 yr	204-54	54"x150'	335.00	.50	
206	3.0 mil - Gloss Clear Vinyl Clear Low-Tack Removable Adhesive 90# Layflat Liner	3 yr / 1 yr	206-54	54"x150'	355.00	.50	
			206-60	60"x150'	399.00	.53	
218	WindowMark™ Blockout 8.0 mil - Gloss White Dual-Layer Blockout Vinyl Clear Removable Adhesive 90# Layflat Liner	3 yr / 1 yr	218-54	54"x100'	490.00	1.09	
219	6.0 mil - Gloss Clear Semi-Rigid Vinyl Clear Low-Tack Removable Adhesive 90# Tight Release Liner	3 yr / 1 yr	219-54	54"x100'	323.00	.	
221	6.0 mil - Gloss White Semi-Rigid Vinyl Clear Low-Tack Removable Adhesive 90# Tight Release Liner	3 yr / 1 yr	221-54	54"x100'	324.00	.75	
			221-60	60"x100'	359.00	.60	
223	6.0 mil - Matte White Semi-Rigid Vinyl Clear Low-Tack Removable Adhesive 90# Tight Release Liner	3 yr / 1 yr	223-54	54"x100'	314.00	.70	
			223-60	60"x100'	350.00	.58	
255	3.0 mil - Optically Clear Gloss Vinyl Optically Clear Solvent Removable Adhesive 2.0 mil Traction Backed Polyester Liner	3 yr / 1 yr	255-54	54"x150'	547.00	.81	
228	TransMark 6.0 mil - Matte White Translucent Vinyl Clear Removable Adhesive 90# Layflat Liner VERIFONEMEDIA Taxi Top Approved	3 yr / 1 yr	228-54	54"x100'	679.00	1.51	

229 HTR WALL VINYL MATTE WHITE REMOVABLE ADHESIVE



Embossed Canvas Wall

262 HTR WALL VINYL MATTE WHITE REMOVABLE ADHESIVE



Sand Embossed Wall

263 HTR WALL VINYL MATTE WHITE REMOVABLE ADHESIVE



Stucco Embossed Wall

264 HTR WALL VINYL MATTE WHITE REMOVABLE ADHESIVE



Leather Embossed Wall

229HTR+ NEW	WallMark® Canvas HTR 6.0 mil - Matte White Embossed Canvas Wall Vinyl Clear Solvent High-Tack Removable Adhesive 90# Layflat Liner	5 yr* / 1 yr	229HTR	54"x100'	604.00	1.34 sq.ft.	
262HTR+ NEW	WallMark® Sand HTR 6.0 mil - Matte White Sand Embossed Wall Vinyl Clear Solvent High-Tack Removable Adhesive 90# Layflat Liner	5 yr* / 1 yr	262HTR	54"x100'	604.00	1.34 sq.ft.	
263HTR+ NEW	WallMark® Stucco HTR 6.0 mil - Matte White Stucco Embossed Wall Vinyl Clear Solvent High-Tack Removable Adhesive 90# Layflat Liner	5 yr* / 1 yr	263HTR	54"x100'	604.00	1.34 sq.ft.	
264HTR+ NEW	WallMark® Leather HTR 6.0 mil - Matte White Leather Embossed Wall Vinyl Clear Solvent High-Tack Removable Adhesive 90# Layflat Liner	5 yr* / 1 yr	264HTR	54"x100'	604.00	1.34 sq.ft.	

Digital Print Media for Eco-Solvent, Solvent, Latex & UV Curable Inkjet Printers

SERIES	PRODUCT DESCRIPTION	DURABILITY / REMOVABILITY	PART #	SIZE	ROLL PRICE	per sq. ft.	ADHESIVE / INK TYPE
--------	---------------------	---------------------------	--------	------	------------	-------------	---------------------

207	7.0 mil - Clear Static Cling 90# Layflat Liner	3 mo / -	207-54	54"x75'	191.00	.57	
-----	--	----------	---------------	----------------	---------------	------------	---

208	7.0 mil - White Static Cling 90# Layflat Liner		208-54	54"x75'	196.00	.58
-----	--	--	---------------	----------------	---------------	------------

790AE NEW	Print-n-Privacy 3.0 mil - Polymeric Glass Etch Film (Light) Clear Solvent Permanent Adhesive 90# Paper Air Egress Liner (Dry Apply Only)	7 yr / -	790AE-60	54"x75'	570.00	1.69	 Printable w/Solvent, Latex or UV
------------------	--	----------	-----------------	----------------	---------------	-------------	---

WRAP FILMS

WRAP FILMS

230	AutoMark 2.4 mil - Gloss White Conformable Wrap Vinyl Grey Solvent Permanent Repositionable Adhesive 90# Air Egress Layflat Liner	7 yr / 2 yr	230-54	54"x150'	739.00	1.09	
-----	--	-------------	---------------	-----------------	---------------	-------------	---

230-60	60"x150'	822.00	1.09
---------------	-----------------	---------------	-------------

Part Roll Price - 54" Wide
1-9 yds. -18.6 0 yd. 10-49 yds.-17.00 yd.

231	AutoMark 2.4 mil - Gloss Clear UV Wrap Laminate Clear Solvent Permanent Adhesive 53# Liner	5 yr / -	231-54	54"x150'	476.00	.70	
-----	---	----------	---------------	-----------------	---------------	------------	---

231-54	54"x150'	476.00	.70
---------------	-----------------	---------------	------------

Part Roll Price - 54" Wide
1-9 yds. - 12.00yd. 10-49 yds.- 11.30 yd.

240	AutoMark 2.4 mil - Matte Clear UV Wrap Laminate Clear Solvent Permanent Adhesive 53# Liner	5 yr / -	240-54	54"x150'	476.00	.70	
-----	---	----------	---------------	-----------------	---------------	------------	--

240-54	54"x150'	476.00	.70
---------------	-----------------	---------------	------------

333 NEW	AutoMark 3.0 mil - Gloss White Polymeric Vinyl - 7 yr. Clear Slideable Repositionable Solvent Adhesive 105# Air Agress Liner	7 yr/-	333-54	54"x150'	590.00	.82	
----------------	---	--------	---------------	-----------------	---------------	------------	---

333-54	54"x150'	590.00	.82
---------------	-----------------	---------------	------------

PERF FILM

232	WindowMark 6.0 mil - Matte White Perforated 50/50 Film White Face/Black Back - Clear Removable Adhesive 84# Layflat with Dual Liner Technology (242 Laminate Recommended)	2 yr / 1 yr	232-54	54"x100' (33.3yds.)	429.00	 
-----	---	-------------	---------------	----------------------------	---------------	--

232-54	54"x100' (33.3yds.)	429.00
---------------	----------------------------	---------------

Part Roll Price - 54" Wide
1-32 yds. - 15.95 yd.

20% (80/20)

30% (70/30)

40% (60/40)

50% (50/50)

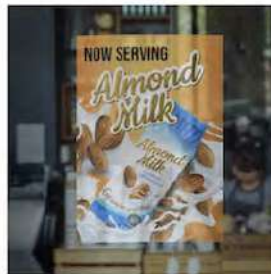

AUTOMARK™ CAST

with DRIFT® Technology



GF 830 AutoMark™ Cast with DRIFT® Technology is a premium full-body gloss white cast wrap film. The DRIFT® Technology and adhesive combination is engineered to provide superior repositionability and slidability. Developed to meet the long-term demands of full or partial fleet and vehicle wraps as well as many other graphic applications. DRIFT® Technology offers the right amount of adhesive tack with Micro Air Egress channels that allow for quick, easy and bubble-free applications. GF 830 AutoMark™ Cast provides an excellent white point, delivering the perfect solution for high-quality printing across Eco-Solvent, Solvent, Latex, and UV print systems.

Applications:

- Vehicle Graphics
- Fleet Graphics
- Outdoor Signage
- POP & Retail Signage

Overlaminates:

- GF 242 OptiMark™ Gloss Optically Clear UV Cast Laminate
- GF 813 AutoMark™ High Gloss Clear UV Cast Laminate
- GF 831 AutoMark™ Gloss Clear UV Cast Laminate
- GF 840 AutoMark™ Matte Clear UV Cast Laminate
- GF 844 AutoMark™ Ulti-Matte Clear UV Cast Laminate

Unique Features:

- Full-Body Cast Film with Superior Repositionability
- Excellent White Point for Vibrant Printing
- DRIFT® Technology provides Enhanced Slidability
- Micro Air Egress Channels, Perfect for Easy
- Bubble-Free Applications



Watch this video to learn more

[CLICK HERE](#)

Adhesive & Liner:



Ink Compatibility:



Product Code	Description	NO.	SIZE	PRICE	SF-\$
830 AutoMark™ Cast w/DRIFT® Technology	2.0 mil - Gloss White Cast Wrap - 8 yr Grey Solvent Slidable, Repositionable, Long Term Removable Adhesive 106# Air Egress (AE) Layflat Liner	830-54	54"x150'	\$1230.00	\$1.82
		830-60	60"x150'	\$1367.00	\$1.82
813 NEW AutoMark™ Cast Laminate	1.3 mil - Gloss Clear Cast Laminate - 8 yr 74# Liner Clear Solvent Permanent Adhesive	813-54	54"x150'	\$867.00	\$1.28
		813-60	60"x150'	\$935.00	\$1.24
831 AutoMark™ Cast Laminate	2.0 mil - Gloss Clear UV Cast Laminate - 8 yr 74# Liner Clear Solvent Permanent Adhesive	831-54	54"x150'	\$932.00	\$1.38
		831-60	60"x150'	\$1006.00	\$1.35
840 AutoMark™ Cast Laminate	2.0 mil - Matte Clear UV Cast Laminate - 8 yr 74# Liner Clear Solvent Permanent Adhesive	840-54	54"x150'	\$932.00	\$1.38
		840-60	60"x150'	\$1006.00	\$1.35
844 NEW AutoMark™ Cast Laminate	2.0 mil - Ulti-Matte Clear Cast Laminate - 8 yr 74# Liner Clear Solvent Permanent Adhesive	844-54	54"x150'	\$932.00	\$1.38
		844-60	60"x150'	\$1006.00	\$1.35

Digital Print Media for Eco-Solvent, Solvent, Latex & UV Curable Inkjet Printers

SERIES	PRODUCT DESCRIPTION	DURABILITY / REMOVABILITY	PART #	SIZE	ROLL PRICE	per sq. ft.	ADHESIVE / INK TYPE
--------	---------------------	---------------------------	--------	------	------------	-------------	---------------------

*LSE SPECIALTY

*LSE SPECIALTY

235



MotoMark - Grip
Matte White 4 mil Vinyl
 Clear Solvent High Bond *LSE Permanent Adhesive
 90# Layflat Liner

5 yr / -

235-24	24x150'	616.00	2.06
235-54	54x150'	1342.00	1.98

*LOW SURFACE ENERGY



238



MotoMark - Armor
Gloss Clear 12 mil UV Laminate
 Clear Solvent Permanent Adhesive
 53# Liner

5 yr / -

238-24	24"x75'	339.00	2.25
238-54	54"x75'	638.00	1.91



STATIC CLINGS

STATIC CLINGS

*207

7.0 mil - Clear Static Cling
 90# Layflat Liner

3 mo / -

207-54	54"x75'	191.00	.57
--------	---------	--------	-----



*208

7.0 mil - White Static Cling
 90# Layflat Liner

3 mo / -

208-54	54"x75'	196.00	.58
--------	---------	--------	-----



*NOT INTENDED FOR INSIDE MOUNT APPLICATIONS. PLEASE SEE PRODUCT BULLETIN AT WWW.GENERALFORMULATIONS.COM FOR SPECIFIC INSTALLATION INSTRUCTIONS.

OPTICALLY CLEARS

OPTICALLY CLEARS

105

2.0 mil - High Gloss Clear Polyester Laminate
 Optically Clear Permanent Adhesive
 1.5 mil Clear Polyester Liner

2 yr / -

105-54	54"x150'	512.00	.76
--------	----------	--------	-----



106

1.0 mil - Transparent Optically Clear Mount Film
 Optically Clear Solvent Permanent Adhesive - Both Sides
 1.5 mil Clear Polyester Liner - Both Sides
**Indoor only*

1 yr / -

106-54	54"x150'	897.00	1.33
--------	----------	--------	------



242

2.0 mil - Optically Clear UV Gloss Cast Laminate
 Optically Clear Solvent Permanent Adhesive
 2.0 mil Smooth Frosted Polyester Liner
OUTFRONT media Approved

5 yr / -

242-54	54"x150'	1031.00	1.53
Part Roll Price - 54" Wide			
1-9 yds. -25.70 yd.		10-33 yds.-23.30 yd.	



255

3.0 mil - Optically Clear Gloss Vinyl
 Optically Clear Solvent Removable Adhesive
 2.0 mil Traction Backed Polyester Liner

3 yr / 1 yr

255-54	54"x150'	547.00	.81
--------	----------	--------	-----



TEDLAR

TEDLAR

108 NEW

Tedlar® by Dupont™
1.0 mil - Clear Tedlar® Overlaminate
 Clear Solvent Permanent Adhesive
 53# Liner

10 yr / -

108-54	54"x150'	1115.00	1.65
--------	----------	---------	------



Part Roll 1 to 9 yds. - 26.20 per yd. 10 to 49 yds - 24.00 yd.

Laminating Films

GENERAL USE & UV LAMINATES

SERIES	PRODUCT DESCRIPTION	DURABILITY / REMOVABILITY	PART #	SIZE	ROLL PRICE	per sq. ft.	ADHESIVE / INK TYPE
		1 yr / -					
100	3.0 mil - Gloss Clear PVC Laminate Clear Permanent Adhesive 53# Liner		100-51 100-54 100-60	51"x150' 54"x150' 60"x150'	325.00 343.00 384.00	.51 .51 .51	
101	3.0 mil - Lustre Clear PVC Laminate 1 yr / - Clear Permanent Adhesive 53# Liner VERIFONEMEDIA Taxi Top Solution Product OUTFRONT / TITAN Approved		101-51 101-54 101-60	51"x150' 54"x150' 60"x150'	325.00 343.00 384.00	.51 .51 .51	
102	3.0 mil - Matte Clear PVC Laminate 1 yr / - Clear Permanent Adhesive 53# Liner		102-51 102-54 102-60	51"x150' 54"x150' 60"x150'	325.00 343.00 384.00	.51 .51 .51	
400	3.0 mil - Gloss UV Clear PVC Laminate 4 yr / - Clear Permanent Adhesive 53# Liner		400-54	54"x150'	391.00	.58	
401	3.0 mil - Lustre UV Clear PVC Laminate 4 yr / - Clear Permanent Adhesive 53# Liner		401-54	54"x150'	391.00	.58	
402	3.0 mil - Matte UV Clear PVC Laminate 4 yr / - Clear Permanent Adhesive 53# Liner		402-54	54"x150'	391.00	.58	
231	AutoMark 2.4 mil - Gloss Clear UV Wrap Laminate Clear Solvent Permanent Adhesive 53# Liner	5 yr / -	231-54	54"x150'	476.00	.70	
			Part Roll Price - 54" Wide 1-9 yds. - 12.00 yd. 10-49 yds.- 11.30yd.				
240	AutoMark 2.4 mil - Matte Clear UV Wrap Laminate Clear Solvent Permanent Adhesive 53# Liner	5 yr / -	240-54	54"x150'	476.00	.70	
238	MotoMark - Armor Gloss Clear 12 mil "ARMOR" UV Laminate Clear Solvent Permanent Adhesive 53# Liner	5 yr / -	238-24 238-54	24"x75' 54"x75'	339.00 638.00	2.26 1.90	
242	2.0 mil - Optically Clear UV Gloss Cast Laminate Optically Clear Permanent Adhesive 2.0 mil Smooth Frosted Polyester Liner OUTFRONT Approved	5 yr / -	242-54	54"x150'	1031.00	1.53	
			Part Roll Price - 54" Wide 1-9 yds. -25.70 yd. 10-33 yds.-23.30 yd.				

DRY ERASE (indoor only)





110 NEW	EraseMark Pro™ 2.0 mil - Commercial Grade Dry Erase Gloss Clear Polyester Laminate High Performance Engineered Surface Clear Permanent Adhesive 53# Liner	5 yr / -	110-54	54"x150'	719.00	1.06	
			Rolls Only				
111	EraseMark™ 2.0 mil - Dry Erase Gloss Clear Laminate Polypropylene Clear Permanent Adhesive 53# Liner <i>*Please review product data bulletin for recommended applications. Intended for short term / indoor use only (3-6 months, not a commercial use product)</i>	- / -	111-54	54"x150'	339.00	.50	
			Part Rolls	1-9 yds.-9.60 yd. 10-49 yds.-8.50 yd. 50 yd. roll -6.78 yd.			

DRY ERASE (indoor only)

Laminating & Mounting Films

FLOOR / DISPLAY / COUNTER MATS (indoor only)

FLOOR, DISPLAY, COUNTER MATS-INDOOR

SERIES	PRODUCT DESCRIPTION	DURABILITY / REMOVABILITY	PART #	SIZE	ROLL PRICE	per sq. ft.	ADHESIVE / INK TYPE
103	5.0 mil - Fine Textured Matte Polycarbonate Laminate Clear Permanent Adhesive 1.5 mil Clear Polyester Liner		103-54	54"x150'	950.00	1.41	
*109	 Traffic Graphic 5.0 mil - Scratch Resistant Textured PVC Laminate Clear Permanent Adhesive 1.5 mil Clear Polyester Liner	- / -	109-38 109-54	38"x150' 54"x150'	566.00 628.00	1.19 .93	
				1 to 9 yds. 14.15 yd. 10yds.-12.95 yd. 1 to 9 yds. 15.70 yd. 10yds.-14.40 yd.			
*211	 Traffic Graphic 6.0 mil - Gloss Clear Light Emboss Clear Permanent Adhesive 53# Liner	- / -	211-54	54"x150'	571.00	.85	
				1 to 9 yds. 14.30 yd. 10yds.-13.00 yd.			
*213 NEW	 Traffic Graphic 3.75 mil - Embossed Clear Polypropylene Laminate Clear Permanent Adhesive 53# Liner <i>Indirect Food Contact Solution</i> - The film and adhesive complies with the following citations in 21CFR 174 thru 182 and 21CFR 175.105 respectively	- / -	213-54	54"x150'	394.00	.59	
*217 NEW	 Traffic Graphic 3.0 mil - Gloss Clear PVC Laminate Clear Permanent Adhesive 53# Liner	- / -	217-54	54"x150'	391.00	.58	

 **TRAFFIC GRAFFIC CLASSIFIED BY UNDERWRITERS LABORATORIES, INC.® AS TO SLIP RESISTANCE ONLY UL410**

SPECIALTY MOUNTING FILMS

SPECIALTY MOUNTING FILMS

106	1.0 mil - Transparent Polyester Optically Clear Mount Film Optically Clear Solvent Permanent Adhesive - Both Sides 1.5 mil Clear Polyester Liner - Both Sides (Indoor only)	1 yr / -	106-54	54"x150'	897.00	1.32	
107	1.5 mil - White Opaque Print Mount Film White Opaque Polypropylene High-Tack Clear Permanent Adhesive - Both Sides 76# Liner (Self-Wound) (Indoor only)	1 yr / -	107-54	54"x150'	492.00	.72	
112	0.5 mil - Clear Polyester Print Mount Film High-Tack Clear Permanent Adhesive - Both Sides 76# Liner (Self-Wound) (Indoor only)	1 yr / -	112-54	54"x150'	530.00	.78	
113	1.0 mil - Clear Polyester Removable Print Mount Film High-Tack Clear Permanent Adhesive 1-Side Low-Tack Clear Removable Adhesive 1-Side Clear 1.2 mil Polyester Liner Printed* (Self-Wound)	6 mo / 6 mo	113-54	54"x150'	562.00	.83	
114	1.0 mil - Clear Polyester Removable Print Mount Film High-Tack Clear Permanent Adhesive 1-Side Low-Tack Clear Removable Adhesive 1-Side 76# Liner (Self-Wound)	6 mo / 6 mo	114-54	54"x150'	564.00	.84	
116*	1.0 mil - Clear Polyester Removable "Air-Egress" Print Mount Film High-Tack Clear Permanent Adhesive 1-Side / 1 mil PET Clear Liner High-Tack Clear Removable Adhesive 1-Side / 4.5 mil Clear Air Egress Printed* PET Liner	1 yr / 6 mo	116-54	54"x150'	851.00	1.26	
118*	1.0 mil - Clear Polyester Removable Print Mount Film High-Tack Clear Permanent Adhesive 1-Side / 1.5 mil PET Clear Liner Low-Tack Clear Removable Adhesive 1-Side / 1.2 mil Printed* PET Clear Liner	6 mo / 6 mo	118-54	54"x150'	608.00	.90	

*Printed with "Remove to Expose Adhesive" on Adhesive Side

gudy® window by



gudy® window

gudywindow is a double sided water-based mounting adhesive that can be applied to the face of a graphic and then face-mounted on interior windows.

Its 1 mil clear polyester carrier has a permanent adhesive on one side and a removable adhesive on the other side.

It allows bubble free application of posters to glass or clear acrylic panels with a simple hand squeegee. Perfect for store-front promotions.



- | | |
|---------------|-----------------------------------|
| Release Liner | Siliconized Paper |
| Adhesive | Permanent Water-based Acrylic |
| Carrier | Clear Polyester (1.0 mil) |
| Adhesive | Removable Acrylic |
| Release Liner | Embossed Low Density Polyethylene |

Price Schedule			
Product no.	Size	Price	Sq.ft.
62082	38"x 200 ft.	725.00	1.14
62083	51"x 100 ft.	447.00	1.05



220222

Intermediate Wide-Format Media



PrintVinyl Gray - Gray Back Adhesive PVG800 Series Vinyl Media

PVG 800 Series is a calendered PVC film designed for wide format printing for indoor or medium term outdoor advertising and promotion on flat or slightly curved surfaces. The product is coated on one side with a opaque gray blockout type acrylic adhesive. **SUITABLE FOR:** solvent, eco-solvent, UV, screen UV & latex printing .



Description	Roll Size	Product No.	Wt. Lbs.	Price/Roll
Matte White Opaque Permanent	54" x 150 ft.	PVG328PW54L150	46	325.00
Matte White Opaque Removable	54" x 150 ft.	PVG328RW54L164	47	325.00
Gloss White Opaque Permanent	54" x 150 ft.	PVG329PW54L150	46	325.00
Gloss White Opaque Removable	54" x 150 ft.	PVG329RW54L150	46	325.00



February 8, 2022

OPT FOR MACTAC® OODLES

Mactac’s high-performance OODLE wall media are known as the industry’s first-and best-wall/poster solutions. Used for elevators, tiled wall murals, posters, decals, stickers, and more. Here is what you need to know:

- Featuring flush edge printing ROODLE® is an aggressive removable media perfect for tiled wall murals, indoor and outdoor signage, bumper stickers and graphics.
- wallNOODLE® is designed for repositionable and removable wall posters, decals and stickers.
- Permanent wallNOODLE® is ideal for barrier graphics and other signage projects where semi-rigid, easy to apply product is required.

wallNOODLE - Ultra-removable, Repositionable	6.0	WN628W54	469.00	N/A	54" x 100'	45
	6.0	RO628W54L100	418.00	4 yr	54" x 100'	45
ROODLE - Removable	6.0	PN628W54L100	402.00	4 yr	54" x 100'	44
wallNOODLE Permanent (wallPOODLE) - Permanent	6.0	PN628W54L100	402.00	4 yr	54" x 100'	44

StreetTRAX® - "ONE-STEP" Outdoor Sidewalk Graphics Vinyl Media

Suitable for: Latex, UV-cured, UVgel Solvent and Eco-solvent inkjet printers
NO lamination needed!



Product Family/Description	Facestock mils	Stock Number	Outdoor Durability	Roll Size	Roll Weight #	Price/Roll 1-9 Rolls
Grit Coated White Aggressive High-tack 	13.5	STX1528V2PW54L100	Up to 1 yr	54" x 100'	40	1785.00
	13.5	STX1528V2PW54L50	Up to 1 yr	54" x 50'	23	928.00

StreetRAP® - "TWO-STEP" Outdoor Sidewalk Graphics Vinyl Media

Suitable for: Solvent, eco-solvent, latex, UV-cured and UVgel inkjet inks and UV or solvent screen inks.

Laminate with: Outdoor floor graphics must be laminated with **PF6654W54L100** slip resistant overlaminating films. **54" x 150 ft. - 1279.00 roll**



Product Family/Description	Facestock mils	Stock Number	Outdoor Durability	Roll Size	Roll Weight #	Price/Roll 1-9 Rolls
Matte White Opaque Aggressive High-tack 	4.0	STR328W54	Up to 1 yr	54" x 150'	60	1485.00
	4.0	STR328L100	Up to 1 yr	54" x 100'	55	998.00
	4.0	STR328L50	Up to 1 yr	54" x 50'	28	539.00

Mactac Print and Stick w/ M-Dot removable adhesive - No lamination

Easy and fast application and removability enabled with the dotted adhesive.

Able to be removed and reapplied. Printability with Solvent - Eco-Solvent - UV - and Latex Printers.

No water or application tools required. **NO LAMINATION REQUIRED.**

MD 199 and MD 228 Designed for indoor **WINDOWS and WALLS.** - **MD128** Designed for **INDOOR FLOORS**

Product	Roll Size	Gauge	Face	Adhesive	Liner	Indoor Only Durability	Prices
MD199W54L164	54"x164ft.	4.7 mil	Gloss Clear	Dot Patterned Removable	5 mil coated paper	up to 1 year	432.00
MD228W54L164	54"x164ft.	4.7 mil	White Matte	Dot Patterned	2 mil	up to 1 year	424.00
MD128FW54L82	54" x 82ft.	7.9	White Matte	Dot Patterned	74# White kraft	up to 6months	353.00

IMAGin[®] by MACTac[™]

Specialty | Solvent-based, UV Cured Ink Jet Media

ROUGH RAP[™]
WALL WRAP GRAPHICS

18 **HIGH GLOSS finish** **TEXTURED finish** **Permanent**



Application: Wall Graphics
Material: RoughRAP[™]

IMAGin[®] RoughRAP[™] is a 2.1-mil soft white gloss, highly conformable PVC film designed for solvent-based ink jet printing. The product is coated on one side with a high-tack, permanent, opaque acrylic adhesive. RoughRAP is specifically designed for direct application onto exterior and interior brick walls for a painted on look. Use of an overlaminate will extend the life of the graphic and allow for easier handling during installation.

Features and Benefits:

- 2.1-mil highly conformable vinyl face
- High-tack, permanent adhesive
- 80# polycoated liner for excellent printability and layflat
- Superior print quality for vibrant images

Typical Uses:

- Exterior and interior brick walls

Roll 54"x 75ft. - 719.00 RR100W54L75
Roll 54"x150ft.- 1398.00 RR100W54L150

Physical Properties	Typical Values
Peel Adhesion , lb./in. 180° on Stainless Steel - 24 hr	3.2-5.0
Quick Tack on SS , lb./in ²	4.8-6.2
Dimensional Stability (shrinkage) , % 48 hours @ 158°F (70°C)	max 0.5
Temperature Ranges Minimum Application: End Use:	50°F (+10°C) -4° to 160°F (-20° to 70°C)
Shelf Life: Two years from D.O.M when stored at 60/77°F (15-25°C) and 50% relative humidity in the original packaging.	

WINDOW PERF VINYL

Rite-Media Vision Perforated

Substrates - Vinyl

Rite-Media Vision Window Perforated vinyl is a white gloss printable polyvinyl chloride (PVC) film with a black back. It is supplied on a universal dual liner, compatible with solvent, eco-solvent, latex, and ultraviolet (UV) printers. Using a clear, removable adhesive, the film can be removed with little to no glue residue. Available with various perforated ratios to fit a large range of applications.

Vision Perf	Roll-54"x50yds.	Cut Pieces(1-49yds.)
60/40 Gloss 6mil Removable	429.00 roll	9.90 per yd.
70/30 Gloss 6mil Removable	429.00 roll	9.90 per yd.



Print Shield® Anti-Graffiti

ANTI-GRAFFITI LAMINATE

[watch demo video here](#)

This product safeguards prints which may become vulnerable to graffiti by making them washable resistant to a very large number of detergents and solvents.

Print Shield consists of a high performance PCTFE film which protects images printed on UV or solvent inkjet printers from a wide variety of stains and chemicals such as paint, permanent marker, and acrylics

Applications include rigid indoor and outdoor displays, outdoor signage, wall murals, point of purchase/tradeshow displays, window graphics, and backlit signs. Designed to be used with inks that have long light-fastness, it is an extremely durable film with an estimated outdoor life of more than seven years (with non-immersed



SELLING PRICES

SIZE	ITEM NO.	1-4 Rolls	5-9 Rolls
54" x 150 ft.	62276	1399.00 roll	1299.00 roll

GF 108

DuPont™ Tedlar® Clear PVF OVERLAMINATE

GF 108 made with DuPont™ Tedlar is graffiti resistant.

A 1.0 mil transparent DuPont™ Tedlar® Clear PVF Film coated with a solvent permanent pressure sensitive adhesive on a 53# overlay liner. Recommended for use in overlay applications requiring extended resistance to UV exposure, color stability, abrasion resistance, and graffiti resistance.

PART #	SIZE	ROLL PRICE	Per Sq. Ft.	ADHESIVE
108-54	54"x150'	983.00	1.46	Permanent clear
Part Roll - 1 to 9 yds. - 26.20 per yd. -		10 to 49 yds. - 24.00 yd.		



161123

[click here for sales sheet & specs.](#)



Anti-Graffiti Clear

1S122

4016, 4018

A two-component topcoat clear with exceptional exterior durability and solvent resistance. Recommended as a protective topcoat over surfaces and substrates painted with catalyzed 1-Shot Background and Lettering Enamels that have been properly catalyzed with 1-Shot 4007 Hardener.



Prices

1 SHOT ANTI-GRAFFITI CLEARS		GAL	QT.	Pint	
4016	ANTI-GRAFFITI CLEAR GLOSS - PART A	246.00	-	49.00	click here for specs on anti-graffiti
4018	ANTI-GRAFFITI CLEAR MATTE- PART A	-	71.65	49.00	
4020	ANTI-GRAFFITI CLEAR - PART B	246.00	-	-	

Features & Benefits

- Excellent exterior durability
- Solvent resistant
- Most graffiti can be removed with solvent

Optional Products

Hardeners: 4020 Hardener

Directions For Use



Mix Ratio:

Anti-Graffiti Clear	Hardener
1 Part	1 Part

- If thinning is required, use no more than 10% Acetone or MEK in the 4016 Gloss and no more than 20% in the 4018 Matte.
- Pot life of mixture is 2 hours at 72° F.



Matthews Paint Toll Free: 800.323.6593 Fax: 800.947.0377
 www.matthewspaint.com www.1shot.com
 760 Pittsburgh Drive Delaware, OH 43015

Product Information Effective 03/14
 Part No. 1S122 03/14
 © 2014 Matthews Paint Company

Adhesives & Additives

® WELD • ON ® CEMENT



Fast-setting, medium bodied, high strength acrylic cement. Also bonds rigid PVC, ABS, styrene, butyrate, polycarbonate to themselves and each other, as well as other plastics and porous surfaces. **5 oz. tube 14.95**



SPRAYWAY 82 MIST TYPE SPRAY ADHESIVE

Created for textile screen printers who specialize in T-shirts and similar materials. Bonds easily to cloth, paper, cardboard, acetate, foil, plastic film, cork, foam rubber, and leather. Pressure-sensitive formula is repositionable without losing strength. Will not transfer to fabric or allow shifting during screen printing process.

13 oz. 12.30



SPRAYWAY 83 WEB TYPE SPRAY ADHESIVE

A quick drying translucent tack adhesive that provides temporary holding of textile fabrics to the printing pallet. Printing can follow immediately after application. After printing, fabrics strips quickly without staining.

13 oz - 11.75



Methylene Chloride

A bonding agent for acrylics/plexiglass. Sold in metal containers.

Quart - 44.25



APPLICATOR SYRINGE

For applying methylene chloride and other solvent cements to: Acrylic, Plexiglas, Lucite, and Acrylite.
1/2 oz. squeeze bottle with 27 ga. needle.
7.95 ea.

3M™ Edge Sealer 3950

1/2pt. Dauber Tin 35.75



Includes felt application dauber
Do not apply directly to painted surfaces

3M™ Edge Sealer can be applied around exposed edges of compatible films to help prevent the film from lifting due to environmental exposure or cleaning.

3M™ Edge Sealer helps minimize the adverse effects of rigorous use or prolonged or severe exposure conditions by providing water and contaminant tight seal between a graphic film and substrate.

3M™ TAPE PRIMER 94

3M™ Tape Primer 94 can be used to promote adhesion of tapes to difficult surfaces such as: polyethylene, polypropylene, ABS, PET/PBT blends, concrete, wood, glass, metal and painted metal surfaces. -1/2 pt. tin - 32.95



3M™ Overlaminat 8914 Tape

Designed for use on Window Perforated Graphic Films.
Provides optically clear graphic protection and prevents moisture and contamination from collecting on base film's perforations. Used as an edge sealer where a film type sealer is needed.
Rolls 1/2" x 75 ft. - 16.75 ea.



p.29

NOTE 4x8 ft. sheets available for delivery only in Toronto GTA & nearby areas eg. Hamilton, Niagara, Cambridge, Kitchener, Oshawa, Whitby, etc. - Phone or email order.

ACM PANELS- ALUMINUM COPOSITE MATERIAL- white, black, brush silver, colors
INEXPENSIVE - LIGHTWEIGHT - HIGH STRENGTH

ALUMINUM SIGN PANEL

3mm - 48"x 96" (4x8 ft. ALUMINUM CLAD PANEL	
3mm gloss white 1 side /matte white other side 4x8 ft.	99.00
3mm gloss black 1 side /matte black other side 4x8 ft.	109.00
3mm brush silver 1 side only 4x8 ft.	125.00
3mm colors -yellow, red, green, and blue -check for price	
6mm 48"x 96" (4x8ft.)	
6mm 1 side gloss white 1 side matte white 4x8 ft.	149.00
6mm 1 side gloss black 1 side matte black 4x8 ft.	180.00
3mm - 48"x 120" (4x10 ft.)	
3mm 1 side gloss white 1 side matte white 4x10 ft.	126.00
3mm 1 side gloss black 1 side matte black 4x10 ft.	131.00
6mm 48"x 120" (4x10ft.)	
6mm 1 side gloss white 1 side matte white 4x10 ft.	208.00
Check with us for availability of other sizes and colors	



brush silver

PLASTICS FOR DISPLAY AND PRINTING



COROPLAST®

Coroplast is an extruded, twin-wall plastic sheet based on a high-impact polypropylene copolymer. This high quality, polypropylene profile sheet is formulated specifically for screen printing, displays and packaging. It uses a copolymer resin to increase impact and low temperature performance while retaining flexibility.

At regular temperatures most oils, solvents, and water have no effect on Coroplast, allowing it to perform under adverse weather conditions or when exposed to harsh chemicals.

Standard colours: White, Natural, Ivory, Yellow, Brown, Red, Orange, Light Blue, Dark Blue, Navy Blue, Silver Grey, Green and Black.

48" x 96" sheets can be assorted for quantity discount columns

4' X 8' sheets	1-9 sheets	10-24	25
White - 4mm (3/16 in.)	17.95	16.95 ea.	15.95 ea.
Colours - 4mm (3/16	22.95	21.95 ea.	inquire
White - 6mm (1/4 in.)	42.00	inquire	"
White - 10mm(7/16in.)	53.85	50.00 ea.	"
Black - 10mm (7/16 in.)	check	"	"
White - 4mm - Ultra Smooth	25.35	"	"

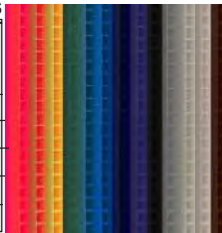

BLANKS-4MM COROPLAST	
SIZE	PRICE
24" x 18"	3.75 ea.
24" x 32"	5.20 ea.
24" x 36"	5.20 ea.

note flute directions

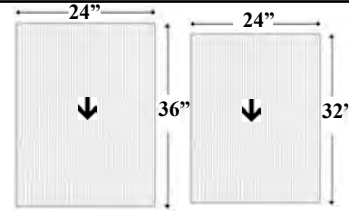

SINTRA

FLAME RETARDANT BOARD is a rigid and strong light-weight foamed P.V.C. board which meets fire code regulations. Sold in 4' x 8' sheets. Colours: Red, Blue, Green, Yellow, Light Grey, Grey, Beige, Black. Sintra material is closed-cell, expanded plastic, high-density polyvinylchloride sheet.

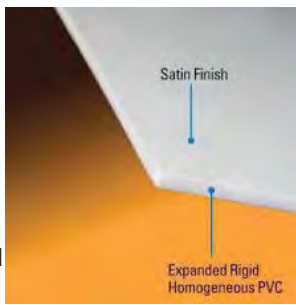

SINTRA PVC BOARD

THICKNESS	WHITE	BLACK	COLOURS
3 mm (1/8")	53.95	check	check
6 mm (1/4")	113.40	check	check
13 mm (1/2")	check	check	check
19 mm (3/4")	check	check	check
25 mm (1")	check	check	check

CREZON® BOARD

4 ft. x 8 ft.
 1/2 inch thick
 Primed 1 side only
 2 year exterior
 \$189.00 sheet

GATORFOAM®

Both Natural and White Gatorfoam panels are amazingly strong and light-weight. You can use them on a multitude of creative projects, ranging from complex theatre sets to simple photo mounts. And, because they are resistant to sun, wind and rain, both can be used indoors and out. Sold in 4' x 8' sheets.



THICKNESS	WHITE	NATURAL	BLACK
5 mm (3/16")	103.00	check	110.00
13mm (1/2")	145.00	check	157.00
19mm (3/4")	check	check	check
25mm (1")	check	check	check

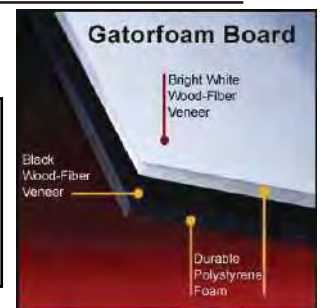

FOME-CORE BOARD

The well known light weight display material. Excellent for signs and displays. Lightweight & rigid. Sizes 48"x96" and 32" x 40" sheets sold singularly or (25 per carton)

48" x 96" and 32" x 40"

3/16" and 1/2" thick



SIZE	COLOR	Part Case	Full Case Price
48"x96"- 3/16"	White	25.00ea.	case (25) 23.00
48"x96"- 3/16"	Black	39.35	Check
32"x40"- 3/16"	White	Discon.	Discon.
32"x40"- 3/16"	Black	Discon.	Discon.
48"x96"- 1/2"	White	66.50	Check for price
48"x96"- 1/2"	Black	Check	Check for price

NOTE 4x8 ft. sheets on this page available for delivery only in Toronto GTA & nearby areas including Hamilton, Niagara, Cambridge, Kitchener, Oshawa, Whitby, etc. - Please Phone or email order for these sizes.

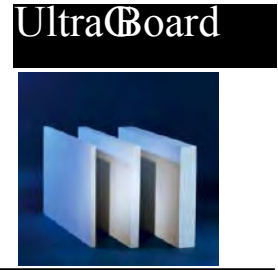

Ultra Board is the ultimate foam board, even stronger than gator board.
 Ultra Board is like Foam Board but with a plastic surface instead of a paper surface.
 Ultra Board is like Gator Board but with a plastic surface instead of a wood fiber surface.
 A heavy-duty, all-plastic foam board with high-impact litho-grade polystyrene surface and extruded polystyrene core.

3/16" 48"x96" White - 112.00	1" 48"x96" White - check	3/16" 48"x96" Black - 124.00
1/2" 48"x96" White - 162.00	1 1/2" 48"x96" White - check	1/2" 48"x96" Black - 186.00
3/4" 48"x96" White - check	2" 48"x96" White - check	1" 48"x96" Black - check

H.I.P.S. (High impact polystyrene)

HIGH IMPACT POLYSTYRENE - WHITE OPAQUE
 A low cost, tough plastic material that is often used for: retail display applications, indoor signs, & POP displays. Can be screen printed, UV Flatbed printed, or decorated with vinyl graphics.

	.010	.020	.030	.040	.060	.080	.100	.125
48"x 96"	quote	17.40	23.95	32.50	52.00	60.80	quote	quote

Translucent White HIPS - .0175 thick - 49" x 74" - 12.95 sheet

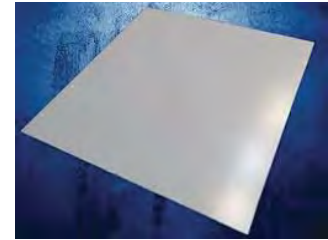

POLYCARBONATE FILM

SHEETS - 24" x 48"- priced per sheet

POLYCARBONATE (LEXAN TYPE)

These films are both decorative and functionally versatile. The wide choice of surface textures provides optimal flexibility in graphic design with a bold contemporary look. Excellent for highly abrasion resistant nameplates and membrane switch overlays.

Type	1-49sheets	50 sheets	175 sheets (case)
.010 Polished Clear	8.95	7.90	7.35
.010 Velvet Matte	6.70	5.70	5.45

Type	1-24 sheets	25 sheets	100 sheets (case)
.020 Polished Clear	15.95	14.85	13.65
.020 Velvet Matte	12.60	11.40	10.25



Note: Also available in 48" width rolls in 25 ft., 50ft. and 100 ft. lengths. Check for price

Tyvek

TYVEK Dupont's durable sheet product has tough tear and water resistance for outdoor durability. If screen printing check for proper screen inks.

Tyvek Type 8740D - .0075 mil	
Roll Size	Roll Price
60" wide x 100 yds.	867.00



A.B.S.

ACRYLIC BUTYLENE STYRENE sheet size 48"x96"

A gloss white plastic; popular for outdoor signage because of superior weathering and flexibility. Also good impact resistance for indoor industrial use. The .020 gauge is widely used for outdoor pole signs.

48"x96"	.020	.030	.040	.060	.118	.177
Check for current prices						

(Special cut sizes - available upon request)

GLOSS VINYL SHEETS-White

GLOSSY 2-SIDED RIGID VINYL White

A rigid vinyl sheet with high impact strength. Economical in price and ideal for signs, displays, vacuum formed parts, templates, calculating instruments, etc.

		.010
OPAQUE WHITE	25" X 52"	3.95



PETG SHEET

CO-POLYESTER THERMOPLASTIC FILM

a transparent film with good impact resistance and thermo-forming features. A low cost alternative to polycarbonate. Has superior chemical resistance and is less brittle than acrylic. **Indoor product.**

SHEET SIZE	PRICE PER SHEET			
	.020	.030	.040	.060
48" x 96"	check for pricing			

APPLICATOR SYRINGE

For applying methylene chloride and other solvent cements to: Acrylic, Plexiglas, Lucite, and Acr; 1/2 oz. squeeze bottle with 27 ga. needle.



7.95ea.

Craftics Plasticator



PLEXIGLAS ACRYLIC

Priced on size, gauge, and specifications. Ask for a price.

Banner Material



Smooth Vinyl Finish with Tough, Interwoven Scrim

14 oz BANANA BANNER WITH Hems and Grommets

Gloss Colors **white black red blue yellow green**

with regular grommets

FINISHED WIDTH		Rolls - 24 yds
22"	22" x 24 yds.	137.00 roll
34"	34" x 24 yds.	183.00 roll
46"	46" x 24 yds.	225.00 roll



Double Grommet DESIGN
Eliminates Waste

Easy flat surface to work on

High Quality #2 spur nickel-plated double grommets are spaced every 24 inches apart.

Consistent
Each roll is exactly the same in gloss, hems, and grommeting



PRE-GROMMETED READY TO PRINT DIGITAL BANNER

by BANANA BANNER - with low profile grommets - for solvent ink jet printing



IMPORTANT - [click here to see video on printing instructions](#)

Roll Size	Roll Price
24" wide x 24 yds.	114.00
36" wide x 24 yds.	168.00
48" wide x 24 yds.	220.00



RM 054 CANVAS - 9oz. Cotton

RM 054 Canvas is a 9oz COTTON based Fine Art Canvas with a white acrylic coating for solvent, eco-solvent, latex and UV printing.

The high white point allows for deeply saturated colors when needed.

RM Canvas is the perfect Premium canvas media for printing of Artist wraps, larger photographs, pictures, giclée framing, pixel wraps, Image wraps, go framing, canvas paintings and art prints.

Picture Wrap Frames to be used are 1.25 or 1.75" in width with lengths ranging from 8" to 60"

Rolls - 54"x 82 ft. - 307.00 per roll Part roll- 14.95 per yd.



RM SOLVENT PAPER - 9 oz.

RM 9mil Gloss or Matte Solvent Paper is a brilliant choice for creating outstanding indoor signage, requiring high-resolution full-color prints. It is compatible with most Solvent, Eco-Solvent and Latex Printers. RM Solvent Paper is available in width of 54" x 100' long.

Applications include: Posters - Murals - Photo Enlargements - POP Displays. Durability- Short term

Rolls - Gloss or Matte - 54"x 100 ft. - 225.00 per roll





DIGITAL BANNER MATERIAL

13oz Single Sided Banner



13oz Promotional White banner, gloss or matte finish.
Excellent for use in promotional indoor or outdoor applications.
Compatible with most solvent ec solvent latex and UV curable inkjet printers.

Easy finish/grommet sewed and hem stitch capable. Abrasion resistant.
Lightweight Great for tradeshow displays - outdoor or indoor signage -

38"x 164 ft. Gloss White (728894) or Matte White (728899) - ea. 167.00 roll

54"x 164 ft. Gloss White (728895) or Matte White (728900) - ea. 237.00 roll



OTHER WIDTHS AVAILABLE

13oz Double Sided Banner



Smooth, opaque and flexible PVC banner with a polyester fabric embedded between two PVC vinyl layers

Gives images a vivid bright appearance

Drapes with ease and delivers high opacity to block back light and shadows. Quick drying, abrasion resistant and water-resistant

Compatible with most solvent, eco-solvent, latex and UV curable inkjet printers.

Great for multiple applications: **indoor/outdoor signage/ building signs/ tradeshow displays, front-lit signage.**

38"x 164 ft. (728892) - 261.00 roll

54"x 164 ft. (728893) - 371.00 roll

OTHER WIDTHS AVAILABLE

10oz PET Grey Back FR Banner



10oz PET Grey Back Banner is made of PVC and PET composite. It is a non-curling banner with a super smooth surface. The grey back makes this banner opaque. It is suitable for solvent and eco-solvent ink; UV curable with good ink absorption, supplying a high-quality printing image with vivid and brilliant colours. This banner is for indoor applications only.

36"x 164 ft. Gloss White - ea. 199.00 roll

54"x 164 ft. Gloss White - ea. 299.00 roll

8 oz Mesh Banner with Liner Backing

Physical Properties

Thickness:

340 Microns/12 mil PVC/PET/PVC composite construction

8oz mesh banner with liner backing

Lightweight mesh material for windy area

Weave minimizes wind resistance and allows air to pass through the material

Comes wound with a special backing material that is removed after printing

54"x 131 ft. (728891) - 275.00 roll

63"x 131 ft. (728908) - 315.00 roll

OTHER WIDTHS AVAILABLE



Pure Color™ Monet Canvas



Monet is a heavyweight 10 oz/yd² coated canvas with a prominent tooth that is ideal for giclée art reproductions, as well as for eye-catching POP signage, trade show graphics and store signage. This strong, yet flexible, canvas features a uniform satin texture and its specialized coating allows for vibrant, photorealistic printing with a wide color gamut. Designed for use with solvent, eco-solvent, latex and UV printers, Monet's tight weave also allows it to be used with vacuum-carried flat bed UV printers.

Item#	Thickness	Roll Size	Roll Price	/ Sq Ft	Roll Weight(lb)	Print Side
WEM30007	10 oz/yd ²	54" x 75'	\$540	\$1.60	26	Image Side OUT
WEM30008	10 oz/yd ²	60" x 75'	\$545	\$1.45	43	Image Side OUT

UltraClear Pet



UltraClear PET is a 4.9 mil optically clear polyester film that can be used for many different graphic and design applications. It has a unique ultra clear silicone adhesive that is both repositionable and removable. This product is great for architectural design, including glass office partitions, POP and retail signage and window graphics. It is designed for use with solvent, eco-solvent, latex and UV-curable inks.

Item#	Thickness	Roll Size	Roll Price	Net / Sq Ft	Roll Weight(lb)	Print Side
6034241	4.9 mil	50" x 98'	\$714	\$1.62	23	Image Side OUT

Pure Color™ Fresco Adtex



Fresco Adtex is a repositionable and removable adhesive textile product made of woven recyclable polyester. It is coated to achieve maximum graphic definition & allow for excellent ink load while also being scratch resistant.

Item#	Thickness	Roll Size	Roll Price	/ Sq Ft	Roll Weight(lb)	Print Side
6318064	10 oz/yd	54" x 100' (1.37m x 30.48m)	\$918	\$2.04	32	Print Side OUT
6318065	Premium Heavy S 10 oz/yd ²	60" x 100' (1.52m x 30.48m)	\$1020	\$2.04	35	Print Side OUT

Trade Show Display Media for Solvent, Eco-solvent, Latex and UV-Curable Inks

Easy Panel 310



This rigid PVC media is specially coated to produce excellent print quality with solvent, eco-solvent and UV inks. The opaque appearance, plus scratch and water resistance when printed with pigment based inks, make this an ideal choice for banner stands and pop-up displays. Its NFPA 701 certification allows for use at trade shows and other public venues.

Item#	Thickness	Roll Size	Roll Price	/ Sq Ft	Roll Weight(lb)	Print Side
6026983	12 mil	42" x 65' (1.07m x 19.8m)	\$459	\$2.02	26	Image Side OUT

Easy Panel 430



This rigid PVC media is specially coated to produce excellent print quality with solvent, eco-solvent and UV inks. The opaque appearance, plus scratch and water resistance when printed with pigment based inks, make this an ideal choice for banner stands and pop-up displays. Its NFPA 701 certification allows for use at trade shows and other public venues.

Item#	Thickness	Roll Size	Roll Price	/ Sq Ft	Roll Weight(lb)	Print Side
6026981	17 mil	36" x 65' (1.07m x 19.8m)	\$523	2.68	20	Image Side OUT

Backlit Display Media for Solvent, Eco-solvent, Latex and UV-curable Inks

CityLight Superior



CityLight Superior is a 8.3 mil front printable translucent backlit film. Designed for use with solvent, eco-solvent, latex and UV-curable inks, this product is for both indoor and outdoor use in a variety of light box and signage applications.

Item#	Thickness	Roll Size	Roll Price	/ Sq Ft	Roll Weight(lb)	Print Side
6031868	8.3 mil	50" x 98' (1.27m x 30m)	\$461	\$1.13	36	Image Side OUT

GROMMETS, MACHINES

HIKER SELF PIERCING GROMMET MACHINE



**Model #
H-901B**

see manual here

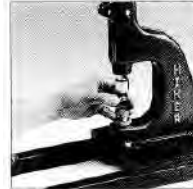

LOAD - Top Die holds grommet firmly.



Pierce & Set - Each Grommet cuts its own hole and washer controls roll over for smooth secure fit



DONE -
• Quality • Speed • Efficiency

FASNAP PM5 SELF PIERCING GROMMET MACHINE



Fasnap Machine with #0, #1, or #2 die	- 425.00
Fasnap Machine with #3, or #4 die	- 435.00
Dies only - #0, #1, #2	each - 170.00
Dies only - #3, or #4	each - 185.00

SELF PIERCING GROMMETS for FASNAP machine only



No.	Size	500	1000
0	1/4" Brass or Nickel	62.00	120.00
1	5/16" Brass or Nickel	67.00	130.00
2	3/8" Brass or Nickel	109.00	198.00
3	7/16" Brass or Nickel	152.00	274.00
4	5/8" Brass or Nickel	163.00	294.00

PRICES

Hiker machine w/either #0,#1,#2,or #1082 die	- 465.00
Hiker machine w/either #3 or #4 die	- 475.00
Dies only - #0,#1, or #2/#1082 die	- 130.00 ea.
Dies only - #3, or #4 die	- 140.00 ea.



Note: #2 Hiker die fits both standard and long barrel #2 Hiker grommets



#2
brass

SELF PIERCING GROMMETS

FOR HIKER MACHINE GROMMETS



PRICES	CAT. NO.	INSIDE HOLE	BRASS		NICKEL OR BLACK	
			500	1000	500	1000
# 0 Grommet	SPU	1/4"	\$50.00	\$82.00	\$59.00	\$93.00
# 1 Grommet	SPV	5/16"	\$67.00	\$117.00	\$78.00	\$137.00
# 2 Grommet	SPW	3/8"	\$78.00	\$133.00	\$87.00	\$150.00
# 3 Grommet	SPX	7/16"	\$99.00	\$176.00	\$113.00	\$201.00
# 4 Grommet	SPY	1/2"	\$138.00	\$239.00	\$158.00	\$277.00
#2 Long Barrel Grommets 10MM or 6MM			\$145.00	\$252.00	\$170.00	\$289.00

LONG BARREL GROMMETS



10mm (1/2" or 6mm (1/4")
for use with 10mm or 6mm stock
eg. foam board, Coroplast, etc.

Available in #2 size only (3/8" inside dia.)
Holes must be drilled due to length of grommet.

Note: Hiker #2 die fits both standard & long barrel grommet.

6MM OR 10MM	1 to 499	500	1000
BRASS	.35 ea.	145.00	252.00
NICKEL	..40 ea.	170.00	289.00

OSBORNE MANUAL GROMMETTING TOOLS

GROMMET DIE SET #216 OSBORNE



No.	Grommet inside hole dia.	Price
216-0	1/4" for #0 grommet	52.95
216-1	5/16" for #1 grommet	56.95
216-2	3/8" for #2 grommet	58.50
216-3	7/16" for #3 grommet	67.00
216-4	1/2" for #4 grommet	73.00

RAWHIDE HAMMER with solid head
#196-2 - 36.00



Rawhide hammers should be used to strike
Setting Dies and Cutters for best results.
Steel hammers are not recommended.

MANUAL GROMMETS AND WASHERS



Osborne Grommet & Washers For Osborne #216 Die Sets & Mini Kits			
No.	Size	Per Box of 144	Brass
#0	1/4" i.d. hole dia.	11.75	
#1	5/16" " " "	14.65	
#2	3/8" " " "	18.50	
#3	7/16" " " "	31.50	
#4	1/2" " " "	38.75	

GROMMET HOLE CUTTER #500



No.	For Grommet size	Price
0A	0-1/4"	27.25
1A	1-5/16"	27.25
2A	3/8"	27.25
3A	7/16"	30.40
4A	1/2"	31.85

MINI GROMMET KIT

FOR SMALL JOBS
(Canvas, plastic,
nylon mesh)

EACH KIT
CONTAINS:

- Grommet Die (Mini)
- Punch (Mini)
- Cutting Board
- Instructions on back pkg.

GROMMETS:

- Kit #0 or #1 contains 4 dozen



PRICES

		Brass	Nickel
#0 KIT	1/4" dia.	26.50	27.80
#1 KIT	5/16" dia.	26.50	27.80
#2 KIT	3/8" dia.	26.50	27.80
#3 KIT	7/16" dia.	31.50	32.50
#4 KIT	1/2" dia.	32.50	34.00



"LEAD FREE"

[see color card here](#)

Lettering Enamels

"ONE SHOT" LETTERING ENAMELS are oil based lead free superior quality high gloss enamels for interior or exterior use on metal, glass (not for use on windshields), wood, masonite, MDO and enamel receptive banner and vinyl materials. Intended for sign writing on store fronts, vehicles and wherever fine lettering work is desired. They have outstanding hiding, durability and excellent resistance to sagging. Superior flow characteristics assure the virtual absence of brush marks and provide a clean, sharp edge.

[click here for SDS sheets \(formerly MSDS\)](#)



[click here for PANTONE Conversion Formula for 1 Shot](#)

CASES - less 10% -1/2 pints (12 per case), pints (12 per case), quarts (6 per case), gallons (2 per case)

CODE	COLOR	1/2 PT.	QTS.	GALLON	CODE	COLOR	1.2 PT.	QTS.	GALLON
100L	Vermillion	32.35	84.65		144L	Medium Green	24.95	63.00	
101L	Lettering White	23.00	58.00	186.05	148L	Dark Green	24.95	63.00	
102L	Fire Red	33.05	87.70	281.75	149L	Aqua	23.00	57.95	
103L	Polar White	23.00	58.00	186.05	150L	Blue Green	23.00	57.95	
104L	Bright Red 106L	32.35	84.50	271.40	151L	Robin Egg Blue	25.45	64.90	
106L	Kool Crimson	32.35	84.50		152L	Light Blue	23.00	57.95	
108L	Maroon	32.35	84.50		153L	Process Blue	32.35	84.50	
109L	Metallic Gold	43.00	143.75		154L	Peacock Blue	25.60	64.90	
110L	Metallic Copper	43.00	143.75		155L	Reflex Blue	32.35	84.50	264.50
111L	Metallic Brass	43.00	143.75		156L	Brilliant Blue	25.60	64.90	
114L	Medium Brown	23.00	57.95		157L	Kansas City Teal	23.00	57.95	
115L	Dark Brown	23.00	57.95		158L	Dark Blue	23.00	57.95	186.05
116L	Ivory	23.00	57.95		160L	Violet	23.00	57.95	
117L	Tan	23.00	57.95		161L	Proper Purple	37.90	100.20	
118L	Chamois	23.00	57.95		162L	Purple	37.90	100.20	
120L	Coral	28.75	72.45		163L	Magenta	37.90	100.20	
124L	Orange	29.30	75.30		164L	Dark Magenta	37.90	100.20	
130L	Primrose Yellow	28.75	72.45		165L	Rubine Red	37.90	100.20	
132L	Lemon Yellow	28.75	72.45		168L	Salmon Pink	32.35	84.50	
134L	Chrome Yellow	28.75	72.45		191L	Imitation Gold	24.95	63.00	
141L	Sublime Green	28.75	72.45		193L	Metallic Silver	25.60	64.90	207.00
142L	Emerald Green	24.95	63.00		195L	Medium Grey	23.00	57.95	
143L	Process Green	25.60	64.90		199L	Lettering Black	23.95	60.50	193.55

1 SHOT CLEAR COATINGS

CODE	DESCRIPTION	GAL	QTS.	AEROSOL
4003	SIGN RESTORING CLEAR GLOSS		37.50	-
4005	SPEED DRY U/V ACRYLIC CLEAR GLOSS	231.15	72.10	-
4005A	SPEED DRY U/V ACRYLIC CLEAR GLOSS AEROSOL			24.15
1 SHOT ANTI-GRAFFITI CLEARS				
4016	ANTI-GRAFFITI CLEAR GLOSS - PART A	246.00	80.25	click here for specs on anti-graffiti
4018	ANTI-GRAFFITI CLEAR MATTE- PART A	246.00	-	
4020	ANTI-GRAFFITI CLEAR - PART B	246.00	80.25	



PEARLESCENT COLOURS



Designed to be used wherever high quality lettering is required. This unique product allows sign artists to incorporate the special effect properties of Pearlescent pigments into their hand lettering work.

1/2 Pint 31.05

[click here for color chart](#)

900P	Vermillion	950P	Blue Green
904P	Bright Red	953P	Process Blue
930P	Primrose Yellow	955P	Reflex Blue
943P	Process Green	962P	Purple
948P	Dark Green	964P	Dark Magenta

GET 1 SHOT FORMULAS FOR PANTONES®

[click here for New Formula Tool](#)



[click here for MSDS sheets on 1 Shot.](#)

CHROMATIC Bulletin Colours



Bulletin Paint

BULLETIN COLOURS are ideal for use on signs and billboards where a full gloss finish is desired. Single coat coverage, fast dry, fast cut in, extreme high gloss and pure colour clarity produce a dazzling finished product. They are formulated as a solvent based enamel for superior durability, workability and easy application on large areas and/or rough surfaces such as billboards or masonry walls. The Bulletin Colours may be brushed, rolled or sprayed to a smooth, glass-like finish.



Note: All items are discontinued when current stocks run out

[CLICK HERE FOR COLOR CARD](#)

		QUARTS	GALLONS
021	Black	out	out
021F	Flat Black	out	out
100	Vermillion	39.22	126.12
101	White	out	out
101SW	Super White	out	out
102	Fire Red	47.50	152.40
104	Bright Red	out	out
106	Carmine	out	148.95
108	Maroon	43.15	138.75
114	Medium Brown	out	out
115	Dark Brown	out	out
116	Ivory	out	108.85
124	Orange	out	out
130	Primrose Yellow	46.45	148.95
132	Lemon Yellow	46.45	148.95
134	Chrome Yellow	46.45	148.95

		QUARTS	GALLONS
140	Light Green	out	138.75
142	Emerald Green	out	138.75
143	Process Green	43.15	138.75
144	Medium Green	39.20	125.35
148	Dark Green	out	out
150	Blue Green	43.15	138.75
152	Light Blue	out	125.35
153	Process Blue	43.15	out
156	Brilliant Blue	43.15	138.75
158	Dark Blue	out	out
162	Purple	66.00	211.00
163	Magenta (Rhodamine Red)	66.00	211.00
164	Process Purple	60.00	192.00
166	Reflex Blue	46.45	148.95
195	Medium Gray	out	out

Cases - Less 10%

SIGN MAKING PAINTS



1 Shot Poster Colours

[click here for color chart](#)

ART AND SIGN POSTER COLOURS are flat oil based paints, which are waterproof, free flowing and self-leveling, will seal porous surfaces, have excellent hiding power and will not wrinkle paper. These products are designed for interior and short-term exterior use on paper, cardboard, muslin, stretched canvas, wood, masonite, metal or glass (not for use on windshields.) They are intended for use by commercial artists and show card writers for displays, designs, backgrounds and accents.

LEAD FREE!



DEAD FLAT WATERPROOF 1 SHOT POSTER COLORS			
SIZE	WHITE	BLACK	COLORS
16 oz. pints	24.85	25.90	23.40
32 oz. qts.	out	out	41.15

3000 White	3007 Purple	3016 Ultramarine Blue
3002 Chrome Yellow	3009 Light Blue	3099 Black
3006 Magenta	3010 Blue Green	

All colors are discontinued when current stocks run out

Fluorescent Enamels



A. R. MONTEITH FLUORESCENT ENAMEL an all-purpose sign enamel for brush, spray or roller. Should be applied over a white background. For maximum light-fastness overcoat with "Filteray A Clear"

COLOURS		PRICES
207-01 Pink	207-07 Bright Yellow	GALLON 214.00
207-03 Red	207-08 Green	QUART 63.00
207-04 Red/Orange	207-09 Blue	
207-05 Orange		
"FILTERAY A CLEAR" - Gallons (only) - 130.00		

CHALKBOARD PAINT Black

Versatile Chalkboard paint is a matte, hard resin finish, suitable for applying to slate, plywood, hardboard and smooth concrete surfaces. **1 Qt. (litre) 29.50**



1 Shot Speed Dry UV Acrylic Clear

UV Acrylic Clear is a multipurpose solvent base acrylic clear with ultra violet absorbers that help protect against colour fading. This product is for interior or exterior use on PVC pressure sensitive vinyl, wood, masonite, MDO plywood, drywall, metal and plastic. A super clear, fast dry and blister/stain resistant topcoat. Excellent for use as a clear overcoat for most inkjet prints.



4005A- 12 oz. Aerosol -	21.00 spray tin
4005- 32 oz. Quart tin	62.70 qt.
4005- 128 oz. Gallon tin	201.00 gal.

CHROMATIC "GRAPHIGUARD" UV MATTE CLEAR TOPCOAT



These UV Resistant Waterborne Matte Clears offer moderate mar resistance and excellent UV protection both for themselves as well as the surface coatings they cover. GRAPHIGUARD Matte Clears are an exceptional choice as a protective topcoat for lettering or Bulletin enamels as well as - UV Ink, Solvent, Eco-Sol, and Thermal Resin Transfer print projects.

Apply Brush, Roller, or Spray



4331030	Matte Topcoat	214.85/ gallon
---------	---------------	----------------



CHROMATIC FLATTENING CLEAR

CLEAR FLATTENING PASTE unlike flattening agents from other industries, Chromatic has created a varnish additive which changes enamels in a range from just off gloss to matte by adding gradual amounts.

4329500	Flattening Paste	42.95 / quart
---------	------------------	---------------

Blockouts and Primers

Block Out White



PBOW602 BLOCK OUT WHITE (4420602) is a high viscosity block out white. Higher in pigmentation than PBOW Block Out White, this material is chosen when virtually complete coverage over a previously painted sign is desired. This is particularly important when topcoating with the more transparent colours and colour mixes. Solvent based.

4420602	Blockout White	99.90/ Gallon
---------	----------------	---------------

CHROMATIC PRIMER/METAL & WOOD WHITE

METAL and Wood Primer White - is a fast drying high opacity primer with good adhesive qualities on both wood and steel. A coarser pigment particle offers the system greater "tooth" than PBOW Block Out White. Metal and Wood primer sands easily. It is also good for use as a primer-burnish ing sealer under gold sizes and may be slightly tinted. Solvent based.



Product No. 4403101 - Gallon - 95.50

CHROMATIC "TI-COTE" VINYL PRIMER



TI-COTE CLEAR PRIMER BARRIER COAT (4331010-GLOSS), is a high performance water based clear primer/barrier coating developed for use on vinyl substrates such as flexible faces, awnings, banners and self adhesive vinyls, to allow the use of enamel topcoats and lettering enamels.

58.19 / Quart	165.55/ Gallon
---------------	----------------

1 SHOT 5004 VINYL PRIMER



A clear, water based primer for vinyl and most rigid synthetic surfaces including expanded PVC, corrugated styrene, ABS plastics and most PVC vinyl film products. 5004 Vinyl Primer creates a barrier against plasticizer migration, making surfaces suitable for finishing with 1Shot Background and Lettering Enamels, Chromatic Bulletin Colors and even Fluorescent and Art & Sign Poster Colors. While milky when applied, 5004 Vinyl Primer dries clear, and is generally ready to accept 1 Shot paint products in 30-40 minutes.

5004 Primer 108.74/Gallon	36.25/Quart
---------------------------	-------------

Thinners - Reducers - Additives - Solvents



6000 REGULAR REDUCER
6001 LOW TEMPERATURE REDUCER
6002 HIGH TEMPERATURE REDUCER

Formulated to improve flow at normal temperature conditions by reducing viscosity without significantly altering the quality of the coating being reduced. The Low Temp Reducer is formulated to improve flow and levelling at low temperatures by reducing the viscosity and accelerating the evaporation rate without significantly altering the quality of the coating being reduced. The High Temp Reducer is formulated to improve the flow and levelling at high temperatures by reducing the viscosity and slowing down the evaporation rate without significantly altering the quality of the coating being reduced. The reducers may be used with Lettering Enamels, Bulletin Colours, Art and Sign Poster Colours, Pearlescent Enamels or Fluorescent Colours.



#6000	Regular Reducer	36.75/qt.
#6001	Low Temperature Reducer	28.80/qt.
#6002	High Temperature Reducer	24.95/qt.



HARDENER (4007) is designed to accelerate drying time for Lettering Enamels, Bulletin Colours and Pearlescent Enamels. The Hardener will extend colour life, increase gloss, and improve adhesion to most substrates. Adding Hardener to the paint will aid in preventing "lifting" when overcoating with "UCO" Urethane Clear Overcoat, Speed Dry UV Acrylic Clear or an automotive "style" clearcoat. Add up to 10% in volume into 1Shot or Chromatic paint. Recommended shelf life is 14 days after tin is opened.



#4007	Hardener	74.00 1 pt.
-------	----------	-------------

TINTING



TINTING BLACK (4001L) AND WHITE (4002L) are tinting bases for use with Lettering Enamels and Bulletin Colours in achieving various shades without affecting the properties of the base coatings.



COLORS	1/2 pt.
4001 Tinting Black	24.55
4002 Tinting White	21.90

THINNER

EDGE "THE SIGN PAINTER'S THINNER"
(4311001)

Is a pre-mixed combination of flow enhancer and reducer for larger scale painting and lettering. This single component reducer/flow enhancer makes it easy to keep the paint flow up, especially when hand lettering larger scale copy and graphics as well as panels and backgrounds.

4311001	Thinner Quart	18.50
4311001	Thinner Gallon	42.50



BRUSH CLEANER

BRUSH CLEANER (4004) a premium product designed for cleaning brushes which have been used with 1 Shot and Chromatic oil based paints. Excellent for reconditioning, softening and renewing hardened natural and nylon brushes and has been specifically formulated not to interfere with the properties of oil based sign paints.



#4004	Brush Cleaner	21.90/qt.
-------	---------------	-----------



PAINT ROLLERS

FOAM ROLLER SLEEVES

"Signwriters favourite" for coating out signs.
Leaves a smooth finish with no lint.
Disposable - Economical



3"	Foam Sleeve (#FM3303)	.89 ea.
3"	Foam Sleeve with handle	2.45 ea.
7 1/2"	Foam Sleeve (#FM 19003)	1.55 ea.
9 1/2"	Foam Sleeve (#FM 24003)	1.95 ea.



MOHAIR BLEND SLEEVES - Our best quality short pile sleeves made of the best quality mohair blend for maximum paint pickup and even paint release. Rugged reusable phenolic cores resist chemicals and solvents. Fully combed and beveled pile for uniform finish. Good for use with epoxy and toluenes. 3mm Pile.



3"	Red Mohair Blend Sleeve	#MH22	- .89 ea.
3"	Red Mohair Blend Sleeve w/handle	#MH221	- 1.30ea.

7 1/2"	Mohair Blend Sleeve #MH7514	- 2.50 ea.
9 1/2"	Mohair Blend Sleeve #MH9514	- 3.15 ea.

WHITE LINT-FREE MINI ROLLERS

6mm (1/4") pile for smooth surfaces. (#D033L0)
Ideal for high gloss and semi-gloss paints.
Latex or oil paints. 1.25 ea.



CAGE HANDLES

3" Cage Handle (#163003) 1.65 ea.
(for use with 3" foam and 3" Lint free)

7 1/2" Cage Handle -(#167566) 1.95 ea.
9 1/2" Cage Handle -(#169577) 2.65 ea.



GOLD LEAF - METAL LEAF

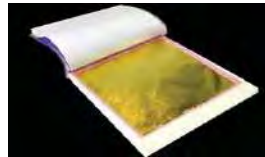

GOLD LEAF is sold by the book, and a book contains 25 leaves. The standard size for Gold Leaf is 3 3/8" x 3 3/8". A book of Gold Leaf will cover approximately 1 1/2 square feet; and 20 books will cover about 30 square feet (including some patchwork).

BOOK (25 leaves) PACK (20 Books)

"GERMAN" GOLD LEAF 23 KARAT (LOOSE) Same high quality as Italian leaf. Ideal for both interior and exterior sign and decorative application. Will not tarnish.	88.00	1489.00
"GERMAN" GOLD LEAF 23 KARAT. (PATENT) Same as German Loose but supplied with individual tissue leaf for exterior gilding in the wind. Will not tarnish.	93.00	1549.00
COMPOSITION (DUTCH METAL) LEAF. is an imitation of gold, and is used for interior decorating only. It will tarnish after a short period of service. The leaves are 5 1/2" x 5 1/2".	15.90	265.00
SILVER LEAF is purer than Sterling. It is a superior grade of Silver Leaf, to be used on glass work only, where it can be properly backed up and protected from the air. If used for other than glass, it will tarnish in a short time.	29.90	495.00
ALUMINUM LEAF is used wherever the colour of silver is desired, and is generally never used on glass. 5 1/2"x 5 1/2"	5.80	108.00

GOLD LEAF SUPPLIES



Gilders Tip

One popular size:
3 1/2" X 2 1/4" length out.
Single thick Squirrel Hair.
The single thick tips are more popular than the double thick, since you can see through the single thick hair and you are less likely to make an error.
Series 1138 - 38.00 ea.

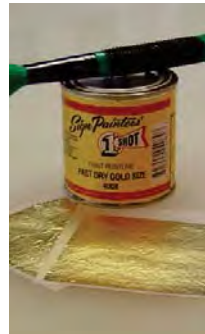

1 SHOT FAST DRY GOLD SIZE

Fast setting allows gilding to begin in one hour. Use with quill, brush, roller or spray.

1/2 Pint size #4008 - \$39.95

"DUX" Gold Size. Quick Drying, ready to gild in 1 to 3 hrs. Great for rush jobs. Drying action may be slowed by adding oil. Works well with gold or aluminum leaf. Colour may be added.
Pint size - 47.75

"DUX" Water Based Size
Designed for all INTERIOR leaf work. A water based gilding adhesive (size) where extended tack time is required. Emission Safe. No fire hazard
Minimum Toxicity Quart - 48.00



"DUX" Oil Gold Size. Slow Drying
Usually ready for gilding in 10-12 hrs. Hold tack for approx. 12 more hours. Ideal for larger projects where extended time is required.
Pint size -47.75



Easel Backs - Showcard Board - Paper

WHITE SELF-STICK . . . EASY DISPLAY

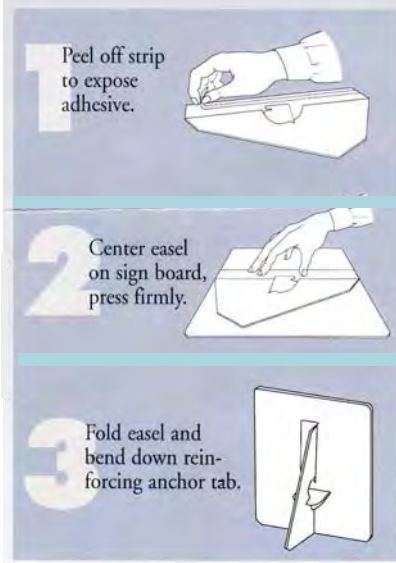

WHITE SELF STICK EASELS

Self-stick easels are attractive, sturdy and easy to use. Application is fast and easy. Simply peel and stick. No messy glue.



note: - attached sign not included

SINGLE WING WHITE SELF STICK

SIZE	1-99	100	box of 500
5" White Self-Stick	.31 ea. .	.28 ea.	.25 ea.
7" White Self-Stick	.37 ea. .	.31 ea.	.28 ea.
9" White Self-Stick	.47 ea. .	.43 ea.	.38 ea.
12" White Self-Stick	.60 ea. .	.50 ea.	.44 ea.
SIZE	1-99	100	box of 400
15" White Self-Stick	.93 ea.	.86 ea.	.78 ea.

DOUBLE WING WHITE SELF-STICK

SIZE	1-99	100	box of 400
7" White Self-Stick	.54 ea.	.47 ea.	.43 ea.
9" White Self-Stick	.66 ea.	.61 ea.	.56 ea.
12" White Self-Stick	.88 ea.	.79 ea.	.72 ea.
15" White Self-Stick	1.90 ea.	1.74 ea.	1.57 ea.



LARGE DOUBLE WING SELF-STICK

SIZE	1-9	10	25
23"	7.85ea.	7.35ea.	6.95ea.
39"	9.85ea.	9.35ea.	8.85ea.
62"	11.85ea.	11.25ea.	10.50ea.

For larger graphics

White - Self-Stick

Sturdy Stock

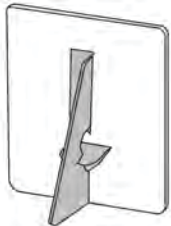

(note: - attached sign not included)

SINGLE WING GREY GLUE-ON EASELS

Quantity	1-24	25	125
18" grey glue-on	1.35 ea.	1.23 ea.	1.02 ea.
Quantity	1-24	25	75
24" grey glue-on	3.32ea.	3.10 ea.	2.84 ea.

Grey 75pt. chipboard Glue-on. Strong and dependable.

An economical alternative to White Self-Stick. Attach with cement, glue, or double-coated tape.

Brown Kraft Paper
Jumbo 8" diameter rolls
200 yards long

36" x 200 yds.	43.75
48" x 200 yds.	52.75



A heavy DD60 general wrapping paper. Also used for Pounce Patterns.

PETERBORO CARDBOARDS Showcard Board -

1900 White Showcard W28" x 44" 14 ply (.50pt.) clay coated white 1 side

PAINTS: - acrylics, latex, tempera, "1 shot Poster"

MULTIMEDIA: - vinyl graphics, felt markers, pen, ink.

8.70ea.

Quantity Discounts on all Peterboro Board 1-9 list
10-24 less 10%
25 sheets- less 15%
sheets can be assorted for discount

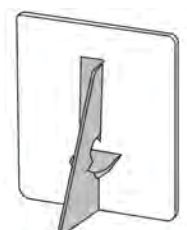

Display Card (easel not incl)

PETERBORO DISPLAY CARD 22" X 28" White 2 sides

#1206 - 22"x28" 6 ply (.027) 2 sides white - 4.20 ea. sheet

#1216 - 22"x28" 16 ply (.058) 2 sides white - 5.30 ea. sheet

MASKING - POUNCING - SIGN TOOLS

MASKING



MACmark®

Paint Mask - Grey

Price per yard

Specialty grey transparent vinyl film designed for paint mask applications. The adhesive is ultra removable and the product is designed for easy cutting on all brands of plotters. Product removes cleanly from most substrates.

WIDTH	1-9 YDS	10 YDS	55 YDS	(Roll)
24"	4.35	4.00	3.67	201.85
30"	5.50	5.00	4.38	241.00
48"	7.65	7.00	6.71	369.00
60"	----	----	8.29	456.00



Paint Mask (Stencil Mask) - white or yellow

A specially formulated PVC facestock with removable adhesive. Used for stencilling on flat or curved surfaces. Excellent for removable vinyl letters. Available in white or yellow

WIDTH	1 to 24 YDS.	25 YDS.	50 YDS. (ROLL)
24"	5.15per yd.	4.60 per yd.	4.34yd. 217.00
48"	9.95 per yd.	9.50 per yd.	8.86yd. 443.00

TUFBAK ADHESIVE-BACK PAPER

Tufbak brand masking paper is a tough, latex impregnated paper with a creped paper liner, protecting an aggressive adhesive. It is intended for painting signs and decorating vehicles. Also used as a stencil by display shops for graphics on plastic signs. Ideal for those jobs where a small amount of Premask is needed.

48" x 25 yd. Roll - 459.00

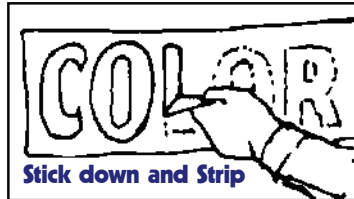
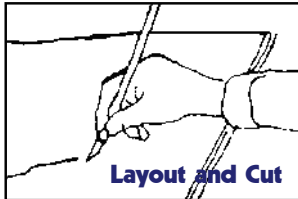

Suction Cups

Metal Hook .53 ea.

1 3/4" diameter clear plastic with a metal hook or a thumb tack.



Ideal for adhering signs to windows.

Quantity discounts for each:

- 1-99 - net
- 100 - less 10%
- 1000 - less 15%

Thumb Tack .31 ea.



Pounce Wheels - 12.95 ea.

- Used for perforating paper to transfer a pattern.
- Sharp pointed spurs for popping vinyl bubbles.
- Can be locked for straight line work or loose to allow for circles or curved designs



Mahl Stick - 25.25 ea.



A necessity if painting fine details is important to your work. This 30" inch mahl stick is used to keep a steady hand at close proximity to your project. It includes 3 ten inch sections that screw into each other, perfect for tight storage or travel. Rubber tip is used to protect artwork.

Graphic Commerce Ltd.

TAPES

FOAM TAPE - rolls: 33 metres/36 yds.



A 1/16" cross-linked polyethylene foam tape, double coated with a solvent-based acrylic pressure sensitive adhesive. Can be applied to any clean smooth surface. Capable of holding great weights. Used for mounting, cushioning, and vibration-damping.

HOT PRICE
LOW PRICE

BUY NOW

1/2"	(12mm)	9.85
3/4"	(18mm)	11.95
1"	(24mm)	15.95



DOUBLE SIDED TAPE

Adhesive on both sides of tape. Excellent for mounting. Easy to use. Holds very tightly.

BUY NOW

WIDTH	CASE	BROKEN CASE	FULL CASE
1/2" x 36 yd.	48	8.25	7.25ea.
3/4" x 36 yd.	36	11.95	10.95
1" x 36 yd.	24	16.25	14.60



203 Masking Tape

3M™ General Purpose
The Standard of the Industry

It sticks to many surfaces and removes cleanly with no residue.



60 yd rolls

BUY NOW

WIDTH	PRICE		CASE	PRICE	
	Part Case			Full Case	
3/4"	3.70		48	3.20 ea.	
1"	4.60		36	4.10	
1 1/2"	6.90		24	6.05	
2"	8.60		24	7.60	

SIGNWRITERS TAPE - 3/8" Green x 72 vd. - rolls- 2.85 per roll



PIN STRIPING



BUY NOW

2 mil cast high performance vinyl. 8 year exterior durability. Available in over 50 colours. See KPMF - STANDARD & METALLIC colour range on page 2 of this catalogue or refer to our SMF colour card. Priced by the 55 yard roll.

SIZE	PRICE	SIZE	PRICE	SIZE	PRICE
1/4"	27.70	1"	64.60	4"	189.20
1/2"	41.25	2"	99.00	5"	235.40
3/4"	59.15	3"	126.90	6"	272.80

The above is Clear Premasked The above is Clear Premasked The above is Paper Premasked

REFLECTIVE STRIPING

KIWA Premium fleetgrade reflective vinyl. 7 year exterior durability. Conforms to flat, irregular, and corrugated surfaces.

Available in 10 colours. - Sold in 50 yard rolls.

See colour range for KIWA reflective on our SMF colour card.



BUY NOW

SIZE	PRICE	SIZE	PRICE	SIZE	PRICE
1/4"	33.65	1"	115.50	4"	440.00
1/2"	64.85	2"	226.60	5"	521.40
3/4"	96.70	3"	324.50	6"	633.60

SOLVENT RESISTANT TAPE

Durable, white polyethylene reinforced cloth tape is pressure sensitive. Has tremendous tack. Perfect for sealing off inside of frames, protecting edges and guides, etc. Molds into all crevices and corners. Simply removed.

2"x60yd.roll-36.65



BUY NOW

BANNER TAPE

1" x 60 yds - Double Coated

Has a very aggressive acrylic adhesive.

Used in hemming & bonding vinyl materials

Roll- 29.95



BUY NOW



[click here for video](#)

watch demo videos

Knifeless Tape

Knifeless tape is a tape that can be used to cut graphic film without a knife see specs



esign Line Tape
1/8" x 164 ft. 53.95



Knifeless Perf Line
1/4" x 164 ft. 53.95

BUY NOW



Knifeless Finish Line
1/8" x 164 ft. 53.95



Knifeless Tri-line
6mm x 164 ft. 64.95
9mm x 164 ft. 64.95



Knifeless Bridge Line
1/2" x 164 ft. 64.95

PACKAGING TAPE- Clear 3" core

2" x 100 metres - "Shurtape" Brand 2.95 roll
3" x 100 metres "Shurtape" Brand 4.95 roll
less 10% on cases - (2" -36rolls case - 3"-24 rolls case)



BUY NOW

TRANSPARENCY MOUNTING FILM

CRYSTAL CLEAR - # 106-54 Double Coated Adhesive Film

Ideal for adhering name plates, plastic to plastic, posters to smooth surfaces, transparencies to plexiglass in light boxes, etc.

ROLLS	CUT PIECES
846.00	21.15 yd.

BUY NOW

54" X 50 YARDS



LETTERING QUILLS

Lettering Quills **Graduated Series Extra-Fine Quality Made in France**

Grey Quills

GREY Talaoutky squirrel lettering quills with attached handles are designed for use in enamels and heavier colours. Finest selected grey squirrel hair. Set in special quills to a thin straight even edge, wire-bound, and attached on wood handles with rounded ends. Stronger and longer than brown squirrel

Brown Quills

BROWN Kazan quill lettering quills with attached handles are designed for enamel and oil colors on plastic and other smooth services. Finest selected brown French squirrel hair. Set in special quills to a thin straight even edge. Wire bound and attached on wood handles with rounded ends.



Grey - Series 189L - Black Handles

SIZE	PRICE
0	\$16.50
1	17.15
2	18.35
3	18.75
4	20.95
5	22.30
6	26.85
7	27.85

SIZE	PRICE
8	\$29.90
9	32.00
10	41.00
12	46.25
14	51.00
16	56.00
18	59.00
20	67.00

Brush Cleaning and Care

Always clean out a brush thoroughly after use. The general rule for cleaning: the solvent or thinner that goes with the paint being used, becomes the cleaning agent. If the paint or medium you are using is compatible with mineral spirits, it is suggested using this as a cleaning agent.

When brush is cleaned, carefully wipe the hair without pulling. Storing the brush greased with light oil prevents any residual paint from drying on the brush.

Do not allow cleaning agent to get into the glued part of the brush, some cleaning agents can attack the glue and cause the hair to loosen.



Brown Series 179L

Finest Brown Squirrel Hair - Natural Quill - Red Handles



SIZE	PRICE
0	\$15.90
1	16.20
2	16.60
3	17.20
4	18.45
5	18.95
6	23.70
7	24.00
8	26.40
9	27.40

SIZE	PRICE
10	32.70
12	38.00
14	39.00
16	42.45
18	44.70
20	47.70
22	49.00
24	54.00
26	59.00

Brush Conditioner & Cleaner #4004

Created specifically for cleaning and storing brushes which have been used with oil based paints.

Quarts: \$19.35



BUY NOW

Brush Boxes

all aluminum

Protects your brushes while drying, storing, & transporting



5"x14" Brush Box #62 brushes are held in place with 3 steel spring coils

\$48.95



5"x 6 1/2" Box#31 specifically designed for pinstriping brushes. Brushes held in place with one steel spring coil

\$32.95

BUY NOW

Scharff Quills

Mfg. in France



Long recognized as one of the highest quality sign quills ever made. Scharff Series 2000 Round Grey-Line Quills have graduated hair length and are all lightweight for good control. They are excellent for lettering on smooth, glassy surfaces; with enamels, oils, Japans, synthetics and other like colours. The choicest Grey Talaoutky Squirrel hair is attached with non-corrosive brass wire and in plastic ferrules.

Series 2000 Round Grey-Line Quills

SIZE	PRICE
0	\$29.40
1	30.50
2	31.50
3	32.50
4	33.85
5	35.50
6	38.15
7	39.90

SIZE	PRICE
8	\$42.40
9	43.50
10	49.40
12	55.95
14	62.65
16	68.75

MACK

SCHARFF

FLAT ONE-STROKE BRUSHES



MACK JET STROKE SERIES 1962

One of the most popular sign lettering brush ever produced. It's ideal for paper, muslin, and board signs. Used extensively for truck lettering. Finest Camel-Oxhair, seamless nickel ferrules with brown handles.



SIZE	PRICE
1/8"	\$5.85
1/4"	8.65
3/8"	10.85
1/2"	14.35
3/4"	24.35
1"	30.30
1 1/4"	49.45
1 1/2"	54.95

Lettering-One Stroke Signwriters - Mack Series 160

(REPLACES LANGNICKEL 6076)

This is a stroke or lettering brush that is normally used for bigger show card and lettering work. The brush is suitable for most any surface. Because of the sable hair in the brush, it has a lot of snap and makes a nice straight razor edge. It is made with sabeline hair and has a flat ferrule.



Sizes	1/8"	1/4"	1/2"	3/4"	1"
Hair Length	11/16"	13/16"	1 1/16"	1 1/4"	1 1/2"
Prices	5.50	7.60	11.50	18.95	26.40

Mack Series 2962 One-Stroke

- * Approximately 50% Brown Taklon & 50% Pure Kazan Squirrel.
- * Our preferred mixtures for water base & acrylic paint. Also used for enamels.



Sizes	1/8"	1/4"	3/8"	1/2"	5/8"	3/4"	1"
Hair Length	1 1/8"	1 1/4"	1 3/8"	1 1/2"	1 5/8"	1 3/4"	1 7/8"
Prices	6.60	7.95	9.85	12.15	14.25	20.50	32.95

(replaces Langnickel 226 One Stroke)



Mack Series 2179

Lettering Brush

50% pure squirrel & 50% Taklon

Sizes	0	1	2	4	5	6	8	10	12
Hair Length	11/16"	3/4"	7/8"	1"	1-1/16"	1-1/8"	1-3/16"	1-5/16"	1-3/8"
Prices	7.35	7.45	7.95	8.75	9.45	10.95	12.35	13.00	16.50

(replaces Nocturna 6056 Lettering Brush)



Mack Series 818 Red Sable Lettering & Showcard Brush

Red sable is more flexible and durable than squirrel. After painting it returns easily to its initial shape. The shorter hair length gives more control. However, red sable is not as soft as squirrel and will not carry as much paint.

Sizes	2	4	6	8	10	12	14	16
Hair Length	21/32"	3/4"	7/8"	1-5/16"	1"	1-1/8"	13/16"	1-1/4"
Prices	10.45	11.00	13.75	15.60	18.85	23.75	35.50	45.00

(replaces Langnickel 65S Showcard Brush)

BRUSHES

FOR PINSTRIPING, DESIGN & SCROLL WORK



Series 20 - North America's No. 1 Automotive Touch-Up Brush

Used by all leading Body Shops for Paint Touch-Up and Pinstriping. Finest quality squirrel hair Stripers made lacquer and enamel resistant. The Sword Style is the best for all-around work. Excellent for auto body touch-up and pinstriping. Made from 100% pure unmixed squirrel hair.

SIZE	PRICE
00	13.80
0	14.40
1	15.75
2	16.95
3	18.35
4	19.65



XCaliber Striper

What makes the XCaliber Striper special is its short hair length (only 1-1/2 inches vs. the average 2 inch & 2-1/4 inch). This shorter hair length allows greater control for intricate designs as well as long lines. Available in 0000, 000, 00, & 0.

SIZE	PRICE
0000	22.85
000	23.50
00	24.00
0	24.75



Series 10 - Original "Mack" Sword Striping Brush

Original "Mack" Sword Striping Brush is made from 100% unmixed Blue Squirrel Hair. Hand crafted and shaped as it was many years ago. Extra attention given to Quality Control with respect to shape & cleaning. The very finest grade of Blue Squirrel. Our new "Blue" thread ferrule.

SIZE	PRICE
0000	18.60
000	19.60
00	20.25
0	21.00
1	21.60
2	22.90
3	24.25
4	25.50



"Mack-Lite"



The "Mack-Lite": The striper with less belly. The shape is similar to the "Old Dominican", which was discontinued several years ago. Made with kasan squirrel hair and bound with a brass ferrule. Length out is graduated from 1-5/8" to 2". Available in sizes 00, 0, 1, & 2.

SIZE	PRICE
00	26.50
0	27.40
1	27.95
2	28.80



"Mack-Belly"



The "Mack-Belly": Exactly like the "Mack-Lite", only more "belly" to the shape in order to carry more paint. Same sizes & length out as the "Mack-Lite". Made with kasan squirrel hair.

SIZE	PRICE
00	25.40
0	26.25
1	27.00
2	27.80



"Fast-Lite"



The "Fast-Lite": Similar to the "Mack-Lite", only the hair length is longer, and it is made with blue squirrel hair. Length out is graduated from 1-7/8" to 2-1/4". Available in sizes 00, 0, 1, & 2.

SIZE	PRICE
00	27.80
0	28.50
1	29.30
2	29.95



Series 250 - The Long Handle Striper



The Long Handle Striper is great for design work and hard to reach areas. Black lacquered handles. Graduated hair length from 1-5/8" to 2". Brown kasan squirrel hair, seamless nickel ferrules. Overall length 8-1/2" to 9". Available in sizes 000, 00, 0 & 1.

SIZE	PRICE
000	16.90
00	18.95
0	22.00
1	27.75

Kafka Pinstriping Brushes

Scroller Series 1660

see detailed description here



Kafka Short Stroke Scroller Series 3 - One size only - 22.50



PRICES - SCROLLER SERIES		
SIZE	HAIR LENGTH	PRICE
0	1 3/4"	20.75
1	1 3/4"	20.75
3	1 3/4"	20.75
5	2"	21.25
6	2 1/4"	21.25

Kafka Longliner Brushes

see detailed description here



SIZE	PRICE
5 x 0	23.50
3 x 0	23.50
00	23.50
0	24.50
1	24.95

Kafka

PINSTRIPING BRUSHES

Kafka Signature Series Scrollers series 1660

All Kafka signature series pinstriping brushes can turn corners without “flare-out” and without the user “rolling the brush”— just lift and work the tip for designs that usually take years to master. Works equally well with urethanes and oil-based enamels

Size 0 — 20.75 ea. The size 0 brush is the smallest available. It’s capable of turning very tight corners and very fine design work while still maintaining great line consistency due to the nature of design and combination of synthetic and natural hair.

Size 1 — 20.75 ea. The size 1 is slightly larger than the 0 and will perform the same as the 0 with a slightly heavier line. As with all the Kafka brushes, they perform with oil-based enamels as well as urethane striping paint.

Size 3 — 20.75 ea. The size 3 will work in a wide variety of applications from scroll striping to shorter, long-line designs. This brush will give the user greater control in all applications and flatten the learning curve for novice strippers. The size 3 is also the most used favorite of its designer, Steve Kafka.

Size 5 — 21.25 ea. The size 5, which is slightly larger than the size 3, holds more paint and will accomplish heavier designs with ease. Depending on pressure, the line thickness can reach 1/4” and fine lines to 1/16” in the other direction. This brush is a favorite for outlining larger flame layouts, cars, trucks, and semi trucks.

Size 6 — 21.25 ea. The size 6 will give you the heavier lines needed in many instances, but still can deliver delicate design work. It’s used for initial layouts followed by smaller sizes for more delicate additions in beautiful combinations.

Kafka Signature Series Longliners

This series of longliner brushes was designed to run consistent, long lines with greater line quality and control. The handles were left long so they may be trimmed to fit inside the web of your hand, or to use as they are. The longliner series has received incredible accolades from all of the top long-line pinstripers

Size 5/0 — 23.50 ea. The 5/0 is the finest longliner brush available. It will lay pin lines for incredible distances with ease and beautiful line quality. It soon will become the standard for the fine line strippers everywhere.

Size 3/0 — 23.50 ea. The 3/0 will match any brush currently available for fine line work, but surpasses them all for durability, line quality, and control.

Size 00 — 23.50 ea. The 00 is probably favored for lines on most cars. Other brands of brushes include the size 00, but when you use our other sizes the reason for us making a variety becomes clear.

Size 0 — 24.50 ea. The size 0 brush performs all longliner functions as the size 1, just not as heavy. Synthetic and natural hairs are used for long life, line consistency, and control.

Size 1 — 24.95 ea. Size 1, the largest brush of this series, holds lots of paint and will do over a 1/4” (6.4 mm) line with ease. It will also do fine lines with less pressure perfectly

Kafka Design Series Short Stroke Brush

we have a shorter version of our number one seller, the #3 signature series scrolling brush. This will help the new pinstriper navigate intricate loops and scroll designs easily and flame outlines will be achieved with greater ease.

It has a gold plated ferrule, a dark stained natural wood handle, and the most successful hair combination. **One size only. - 22.50 ea.**

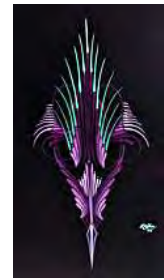

[click here to see video](#)

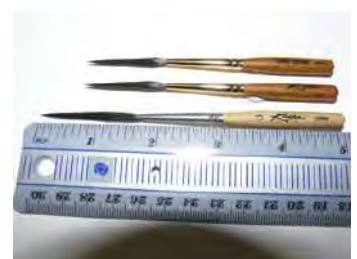

Signwriters Bulletin Fitches & Cutters



LUCO SERIES #1640
SHORT-FAVOURITE
 A standard short bristle fitch for clean accurate work on sheet metal, cardboard and other smooth surfaces.

SIZE	PRICE
1/4"	\$ 11.95
1/2"	12.95
3/4"	16.00
1"	23.85
1 1/4"	29.50



LUCO SERIES #1700s
LONG - SUPER
 A longer bristle for rough or pitted surfaces such as wood or brick. Carries more colour than the favourite.

SIZE	PRICE
1/4"	\$ 13.20
1/2"	14.50
3/4"	19.75
1"	29.50



Angular Fitch Liner

SERIES 4090

• **Finest 100% White Hog Bristle** • **Seamless Nickel Ferrules** • **Long Blue Varnished Handle**

This angular fitch is good for awning work. Sign painters also find it easier to use an angular brush when working on a wall or upright surface. It is good for outdoor work (awnings, walls, bulletins and rough surfaces). This brush is not chiseled. There is no advantage to chisel an angular liner, since most sign painters want an even down stroke.



SIZE	PRICE
1/4"	3.95
1/2"	5.75
3/4"	7.85
1"	11.50

LUCO BULLETIN CUTTERS #1808 WHITE BRISTLE CUTTER

SIZE	PRICE
1 1/4" 30mm	15.25
1 1/2" 40mm	17.55
2" 50mm	26.35
2 1/2" 60mm	31.90
3" 70mm	37.35
3 1/4" 80mm	45.95



Our best Red Sable Brush. Perma Point Series 520

Natural tips, hand cupped to needle-sharp point. Short hair length.

Used extensively by photographers, photoengravers, lithographers and artists for retouching, spotting, opaquing and for cleaning up lettering and type to be reproduced. Rustproof nickel plated seamless

SIZE	PRICE
00000	\$ 7.10
000	7.45
00	7.70
0	7.95
1	8.75
2	10.25
3	10.90



Retouch Brushes

LUCO-LON Synthetic Sable Series #19

A synthetic sable that performs equal to most pure sable brushes. Excellent elasticity. Split -proof point. Will hold large amounts of colour, yet paint a fine line. Ideal for dry brush techniques.

SIZE	PRICE
000	\$ 5.85
00	5.95
0	6.10
1	6.45
2	6.75
3	7.50

SIZE	PRICE
4	\$ 7.95
5	8.95
6	9.95
8	11.30
10	14.50
12	17.45

LUCO-LON Synthetic Sable Retouch #14



A synthetic sable brush for retouching, spotting, opaquing. Extra sharp point with good color retention. Performs well with all media.

SIZE	PRICE
10 x 0	\$ 4.65
2 x 0	4.85
0	5.00
1	5.15
2	5.75
4	6.95

A-FRAMES TOP LOAD

2 Sides Available for Inserts
(Inserts not included in prices.)



48.95

A-203T Top Load
24" w x 36" h insert size.

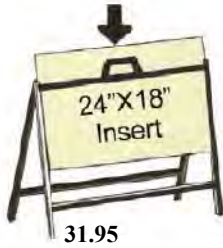

31.95

A-218 Top Load
24" w x 18" h insert size.

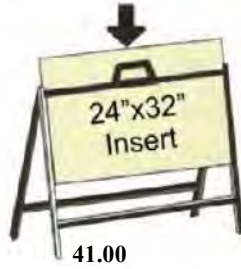

41.00

A-232 Top Load
32" w x 24" h insert size.



39.95

A-2424 Top Load
24" w x 24" h insert size.



49.90

A-218V Top Load
18" w x 24" h insert size.

A-FRAMES SIDE LOAD



68.00

A-324 Side Load
32" w x 48" h insert size.



58.95

A-204 Side Load
24" w x 48" h insert size.

2 POST FRAMES

32" or 36"	24"
TWO POST FRAME	TWO POST FRAME
2 Part Construction	1 Part Construction
Available in 2 sizes	Available in 4 Insert Sizes
TPF2432- 73.65 TPF2436- 83.95	All sizes 42.50 Specify insert Size
Insert Sizes are: TPF-32W - 32"Wx24"H TPF-36W - 36"Wx24"H	TPF-1824 - 24"Wx18"H TPF-2424 - 24"Wx24"H TPF-2436 - 24"Wx36"H TPF-2432 - 24"Wx32"H

A Board

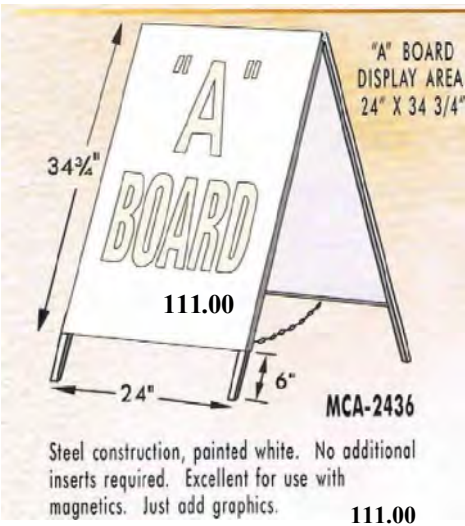

"A" BOARD
DISPLAY AREA
24" X 34 3/4"

111.00

MCA-2436

Steel construction, painted white. No additional inserts required. Excellent for use with magnetics. Just add graphics.

111.00

CRANE SIGN HOLDER

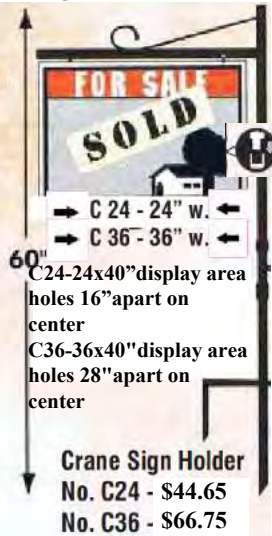

60"
C24-24x40" display area
holes 16" apart on center
C36-36x40" display area
holes 28" apart on center

Crane Sign Holder
No. C24 - \$44.65
No. C36 - \$66.75

STEP STAKES

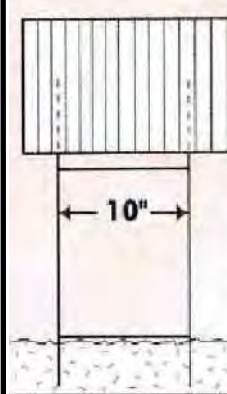

STEP STAKES
for corrugated plastic signs (not included)
Flexible rustproof steel wire construction.
Height - 30". Excellent for election signs, real estate, or any temporary lawn sign.
Available in singles or carrying case of 50
49.00 case/50
less then 50 - 1.30ea.

PRO-LINK



Attach Signs and billboards to chain-link fences.
Includes 1 bracket and 1 5/16"x1" bolt.
Price - 2.95
50-99- 2.35
100 - 2.15

4mm WHITE COROPLAST

Size	Price
24" x 18"	3.75
24" x 32"	5.20
24" x 36"	5.20

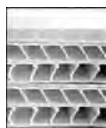

note flute directions

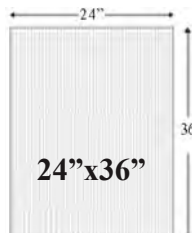
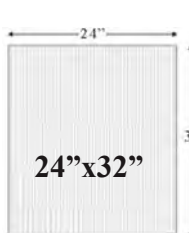

CHECK FOR PRICING ON OTHER SIZES

ALUMINUM SIGN BLANKS . .

051 Thick (16 ga.) coated white 2 sides

Size	w/square corners	w/round corners
12"x18"	15.50 ea.	16.50 ea.
18"x24"	29.95 ea.	30.95 ea.
24"x24"	43.90 ea.	44.90 ea.
24"x36"	64.95 ea.	65.95 ea.



260523

Hinge Handle

8.50ea.

11 1/2" Plastic w/steel insert

Hinge Handle

9.50ea.

15" Plastic w/steel insert



12" Aluminum Hinge Handle

Extra Strong

All metal design

13.50ea.

METAL SIGN HOLDERS



(insert not supplied)

WINDSPINNER

Total height: 39"
DISPLAY AREA:
18" X 30"

W-1836 159.00

Spins with ease.
Heavy duty 30" (diagonal) secure base.
Solid steel construction, can be used with a variety of substrates up to 1/2" thick (not included).
Pegs Included



Chrome Floor Stand
22x28"

ELEGANT AND HEAVY DUTY FLOOR STAND. 67" HEIGHT HOLDS 22"X28" GRAPHIC. STABLE 15" TRUMPET BASE CHROME FINISH.

CFS-2228

194.00



DISPLAY AREA:
22" X 28"

BST-022

BLACK FLOOR STAND
Total height: 60"

\$103.00

PORTABLE OUTDOOR SIGN HOLDER



ACM ALUMINUM COMPOSITE MATERIAL (3MM THICK)
JUST ADD GRAPHICS ON BOTH SIDES

MODERN FRAMELESS DESIGN

EXCELLENT OUTDOOR WEATHERABILITY

24"x36"
\$64.65

EASY AND QUICK ASSEMBLY

POSH 203

STURDY METAL BASE

FLOOR STANDS



23.5"
63"

X-Banner Stand - Only \$24.30
size - 23.5" x 63"
easy to useeffective



AAE 2260

\$36.90

ALUMINUM EASEL
adjustable from 22 inches to 60 inches
WIDTH from 18" to 36". Black - 2.6 lbs.
Use as table top or floor model

Standoffs - 2.95 ea.



2"high 3/4"wide	1 1/4"high 3/4"wide	1"high 1"wide	1"high 1/2"wide
--------------------	------------------------	------------------	--------------------

E-Z CHANGE 'A' BOARD SIGN KIT



Black metal "A" frame - 3 sizes available
2 corrugated plastic boards with tracks
2 clear plastic covers
2 inserts of your choice reading:
"SPECIAL" or "SALE" or "MENU" Kits contain 10 rows of 4" tracks on ea. side and 264 of 4" characters.
Extra sets of 4" characters are 29.50 ea.
Available in sizes:

24" x 36"	#cwa-002-4	195.00
24" x 48"	#cwa-001-4-	249.00
32" x 48"	#cwa-003-4-	315.00

REMARKABLE "A" BOARD KIT



White or Black Panels

- Black metal "A" frame 24"x 36"
- 4 legs
- 2 (RMB 2436) panels .080 HIPS
- 2-1/8" hardboard support panels
- 4 -1/4" ZPM 007 Fluorescent Markers

RMBA KIT - 181.00

extra markers for above:
zpm-007 - 1/4" tip - 4.25ea.
zppb-007 - 3/4" tip - 7.25ea.
zpb-007 - 2" tip - 9.25ea.

COMES WITH 4 ASSORTED FLUOR. MARKERS

DELUXE BANNER STAND



Sleek base
Ideal for long-term use
Holds a 33.4"W x
78.7"H banner
Padded carry bag

Price - 95.00

Please note, the Giraffe Banner Stand is not telescopic.

This Giraffe retractable banner stand is a premium option. The sleek base provides good weight and stability without needing pivoting feet. A protective padded carry bag is included. The Giraffe banner stand is ideal for long-term use in retail advertising, trade shows, and museums.

This stand holds a 33.7" wide by 78.7" high banner. The top bar holds the banner with clamps. At the bottom, a plastic leader with adhesive tape attaches the banner to the spring-loaded retraction mechanism. Instructions for installing and changing the banner are included with the banner stand. They are printed on the plastic banner leader and should be visible as soon as you open the package. If you are changing the banner, you'll need to pull the banner all the way out to see the plastic banner leader. Additionally, the instructions are shown in the product photos on this page.

ALUMINUM ROLL-UP BANNER STAND

The Roll-Up Banner is a cost effective system for shortterm signage or promotions.

It is designed with a reinforced fitting for the pole to ensure the display stands straight -no tilting or leaning.

The top panel profile clamps the media securely in place without the need for adhesive strips and the pole attaches to the top panel from behind with no unsightly hook hanging on top of the graphic.

The included carrying bag unzips lengthwise for greater ease and has extra padding over its entire length to ensure the display stays looking great.



overall size 34"wide x 78" high



A Bargain at 49.90

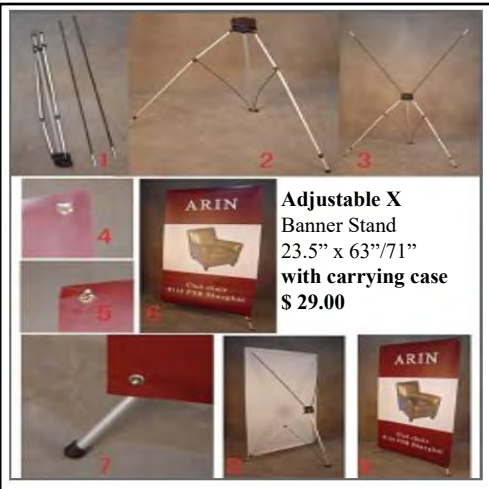

**Adjustable X
Banner Stand**
23.5" x 63"/71"
with carrying case
\$ 29.00



**G.C. Economy
Banner Stand**
(non adjustable)

23 1/2" x 63"
with carrying case

24.30 ea.



GENERAL PURPOSE INK

SUBSTRATES : PAPER AND CARD, WOOD, POLYSTYRENE, VINYL(PVC), ABS, ACRYLICS, TOP COATED POLYESTER, TYVEK ®.

APPLICATION : P.O.P. / DISPLAY , SIGNS , DECALS

Product Information

A long-term multi-purpose outdoor ink designed to print on a wide range of substrates. GP Series ink eliminates the need for carrying a large inventory of different types of ink. Ideal for P.O.P. and general display applications where a semi-gloss finish, scuff resistant surface, is required.

Application Information

Thinning : May be used straight from the can but it is recommended to thin 5 - 15% by weight with GP-1800 Thinner. Substitute GP-1800 Thinner with GP-1820 Slow Thinner to improve screen stability. For maximum lightfastness or outdoor durability, little or no thinning is recommended.

Additives : GP-1700 Clear should only be used to increase transparency of colors. However, this will reduce the durability and lightfastness of the color. To improve scuff resistance add up to 10% GP-1860 Anti-Scuff Agent. Use GP-1350 Overprint Clear to increase scuff resistance or to provide a uniform gloss level to a GP-0000 ink film. Add 5% to 10% of DC-393 Gel Retarder to thinned ink to maintain screen stability. If required, use a small amount of GP-1730 Process Clear to improve print quality.

Wash-Up : GP-1800 Thinner
ITC-1840 Wash-Up

Coverage : Approximately 2100 sq.ft./1 U.S. Gallon using a 280/in. monofilament fabric.

Fabric/Stencil : 200 to 355 monofilament fabric . Direct and indirect photostencil or water soluble hand cut stencils are suitable.

Drying : By solvent evaporation . GP-0000 Series dries in 15 to 30 minutes at normal room temperature or can be jet dried 20 to 45 seconds at 150 °F. to 200 °F. Allow more time between prints for multiple color jobs.

Die Cutting/Creasing/Vacuum Forming : Can be successfully die-cut or creased but should be tested prior to production . GP-0000 series has excellent vacuum forming characteristics. Gloss levels may increase during vacuum forming depending on temperature and substrate used.

Packaging : Inks : 1 U.S. Qt / 0.94 Lt.
1 U.S. Gal. / 3.78 Lt.
Solvents : 1 U.S. Gal. / 3.78 Lt.
5 U.S. Gal. / 19.00 Lt.

CAUTION :

1. It is the printer's responsibility to pre-test the ink selected prior to engaging in a production run .
2. Refer to Material Safety Data Sheet for heavy metal content.

* Based on information received from our suppliers, these colors may contain the deliberate addition of heavy metals.

* Heavy metal free colors are available on request.

GP - 0000 SERIES

Standard Colors

* GP-1010	Red #032
* GP-1020	Fire Red
GP-1030	Brilliant Red
* GP-1040	Bright Red
* GP-1050	Permanent Red
* GP-1060	Red #185 GP-1080
	Maroon GP-1110
	Black GP-1120
	White
* GP-1140	Brown
* GP-1220	Orange
* GP-1240	Vermilion
* GP-1250	Warm Red
* GP-1300	Primrose Yellow
* GP-1320	Lemon Yellow
* GP-1340	Medium Yellow
GP-1350	Overprint Clear
* GP-1420	Emerald Green
* GP-1450	Forest Green
* GP-1480	Dark Green GP-1520
	Opaque Reflex Blue
GP-1540	Peacock Blue
GP-1560	Brilliant Blue
GP-1570	Royal Blue GP-1580
	Dark Blue GP-1620

GP-1640	Cerise
GP-1660	Magenta
GP-1700	Clear
GP-2110	Extra Opaque Black
GP-2120	Extra Opaque White
GP-2150	Yellow C GP-2200
	Rubine Red C
* GP-2250	Orange 021 C
GP-2300	Rhodamine Red C
* GP-2350	Red 485 C GP-2400
	Purple C GP-2450
	Blue 072 C GP-2500
	Violet C GP-2600
	Reflex Blue C

GP-2700	Process Blue C
GP-2800	Opaque Green C
GP-2850	Green C

Transparent Colors

GP-1090	Transparent Red
GP-1290	Trans. Medium Yellow
GP-1390	Trans. Primrose Yellow
GP-1490	Transparent Green
GP-1590	Transparent Blue
GP-1690	Transparent Cerise
GP-1790	Transparent Orange
GP-1990	Transparent Purple

Process Colors

GP-1130	Process Black
GP-1330	Process Yellow
GP-1530	Process Blue
GP-1630	Process Magenta
GP-1730	Process Clear

Fluorescent Colors

GP-0900	Fluorescent Magenta
GP-0910	Fluorescent Orange\Red
GP-0920	Fluorescent Green
GP-0940	Fluorescent Chartreuse
GP-0950	Fluorescent Red
GP-0960	Fluorescent Orange \Yellow
GP-0970	Fluorescent Cerise
GP-0980	Fluorescent Orange
GP-0990	Fluorescent Blue

Thinners and Additives

GP-1800	Thinner
GP-1810	Fast Thinner
GP-1820	Slow Thinner
GP-1830	Extra Slow Thinner
DC-393	Gel Retarder



GENERAL PURPOSE INK

STANDARD COLOURS			
CODE NO .	DESCRIPTION	0.94 L(Qt.)	3.78 L (Gal)
GP-1010	RED #032	89.55	239.80
GP-1010NL	RED #032 (Lead Free)	102.95	275.75
GP-1020	FIRE RED	86.75	234.70
GP-1020NL	FIRE RED (Lead Free)	99.75	269.90
GP-1030	BRILLIANT RED	102.15	277.00
GP-1040	BRIGHT RED	82.50	225.00
GP-1040NL	BRIGHT RED #032 (Lead Free)	98.15	270.00
GP-1050	PERMANENT RED	92.35	253.90
GP-1050NL	PERMANENT RED (Lead Free)	106.15	292.00
GP-1060	RED # 185	89.55	245.55
GP-1060NL	RED 185 (Lead Free)	102.95	282.35
GP-1080	MAROON	149.60	408.45
GP-1110	BLACK	60.85	165.45
GP-1120	WHITE	72.00	194.90
GP-1140	BROWN	72.00	194.90
GP-1140NL	BROWN (Lead Free)	82.85	224.20
GP-1220	ORANGE	74.80	203.30
GP-1220NL	ORANGE (Lead Free)	86.00	233.75
GP-1240	VERMILION	76.95	216.10
GP-1240NL	VERMILLION (Lead Free)	88.50	248.50
GP-1250	WARM RED	102.15	253.90
GP-1250NL	WARM RED (Lead Free)	117.50	292.00
GP-1300	PRIMROSE YELLOW	74.80	203.30
GP-1300NL	PRIMROSE YELLOW (Lead Free)	86.00	233.75
GP-1320	LEMON YELLOW`	74.80	203.30
GP-1320NL	LEMON YELLOW (Lead Free)	86.00	233.75
GP-1340	MEDIUM YELLOW	74.80	203.30
GP-1340NL	MEDIUM YELLOW (Lead Free)	86.00	233.75
GP-1350	OVERPRINT CLEAR	63.65	172.50
GP-1420	EMERALD GREEN	74.80	204.55
GP-1420NL	EMERALD GREEN (Lead Free)	86.00	235.25
GP-1450	FOREST GREEN	71.35	192.35
GP-1450NL	FOREST GREEN (Lead Free)	82.00	221.20
GP-1480	DARK GREEN	70.60	190.45
GP-1480NL	DARK GREEN (Lead Free)	81.25	219.00
GP-1520	OPAQUE REFLEX BLUE	89.55	239.80
GP-1540	PEACOCK BLUE	67.85	185.90
GP-1560	BRILLIANT BLUE	84.60	228.25
GP-1570	ROYAL BLUE	93.70	255.80
GP-1580	DARK BLUE	92.35	253.90
GP-1620	PURPLE	86.75	231.45

GP-1640	CERISE	0.94 L(Qt.) 107.00	3.78 L (Gal) 291.10	
GP-1660	MAGENTA	107.00	291.10	
GP-1700	CLEAR	61.55	169.30	
GP-2110	EX-OPAQUE BLACK	67.85	187.20	
GP-2120	EX-OPAQUE WHITE	74.80	203.30	
GP-2150	YELLOW C	103.50	279.55	
GP-2200	RUBINE RED C	121.70	321.85	
GP-2250	ORANGE 021 C	118.20	323.20	
GP-2250NL	ORANGE 021C <i>(Lead Free)</i>	135.95	371.65	
GP-2300	RHODAMINE RED C	127.30	349.40	
GP-2350	RED 485 C	97.90	269.30	
GP-2350NL	RED #485C <i>(Lead Free)</i>	112.45	309.70	
GP-2400	PURPLE C	105.60	287.85	
GP-2450	BLUE 072 C	97.90	264.15	
GP-2500	VIOLET C	92.35	253.90	
GP-2600	REFLEX BLUE C	86.75	237.85	
GP-2700	PROCESS BLUE C	65.00	176.35	
GP-2800	OPAQUE GREEN C	74.80	201.95	
GP-2850	GREEN C	75.55	207.75	
PROCESS COLOURS		0.94 L(Qt.)	3.78 L (Gal)	
GP-1130	PROCESS BLACK	68.55	185.90	
GP-1330	PROCESS YELLOW	92.35	255.65	
GP-1530	PROCESS BLUE	72.00	194.25	
GP-1630	PROCESS MAGENTA	102.15	277.00	
GP-1730	PROCESS CLEAR	68.55	186.55	
TRANSPARENT COLOURS		0.94 L(Qt.)	3.78 L (Gal)	
GP-1090	TRANSPARENT RED	123.10	338.60	
GP-1290	TRANSPARENT MED. YELLOW	95.80	262.90	
GP-1390	TRANSPARENT PRIM. YELLOW	102.85	279.55	
GP-1490	TRANSPARENT GREEN	84.60	231.45	
GP-1590	TRANSPARENT BLUE	69.25	188.50	
GP-1690	TRANSPARENT CERISE	102.85	279.55	
GP-1790	TRANSPARENT ORANGE	123.10	338.60	
GP-1990	TRANSPARENT PURPLE	104.950	287.85	
FLUORESCENT COLOURS		0.94 L(Qt.)	3.78 L (Gal)	
GP-0900	FLUORESCENT MAGENTA	110.35	303.45	
GP-0910	FLUORESCENT ORANGE/RED	110.35	303.45	
GP-0920	FLUORESCENT GREEN	110.35	303.45	
GP-0930	FLUORESCENT CERISE	110.35	303.45	
GP-0940	FLUORESCENT CHARTREUSE	110.35	303.45	
GP-0950	FLUORESCENT RED	110.35	303.45	
GP-0960	FLUORESCENT ORANGE/YELLOW	110.35	303.45	
GP-0970	FLUORESCENT PINK	110.35	303.45	
GP-0980	FLUORESCENT ORANGE	110.35	303.45	
GP-0990	FLUORESCENT BLUE	110.35	303.45	
ADDITIVE		0.94 L(Qt.)	3.78 L (Gal)	
GP-1720	FLATTENING ADDITIVE	73.00	202.95	
GP-1860	ANTI-SCUFF	134.75	358.85	
DC-393	GEL RETARDER	51.30	136.80	
THINNER AND WASH UP		3.78 L (Gal)	18.9 L 5(Gal)	
GP-1800	THINNER	72.75	300.00	
GP-1810	FAST THINNER	69.85	291.15	
GP-1820	SLOW THINNER	61.75	279.40	
GP-1830	EXTRA SLOW THINNER	80.90	335.35	
ITC-1840	INKTECH # 60 WASH UP (16KG)	N/A	213.75	

GLV - 0000 SERIES

SUBSTRATES : PRESSURE SENSITIVE VINYL FILMS , VINYL COATED PRODUCTS , RIGID AND FLEXIBLE VINYLs , PVC BOTTLES , VINYL TOP-COATED POLYESTER FILMS, ACRYLIC, POLYCARBONATE.

APPLICATION : VINYL BANNERS , DECALS , SUB-SURFACE PRINTING , FLEXIBLE SIGNAGE, PVC CONTAINERS.

Product Information

A multi- purpose, gloss vinyl screen ink designed for printing on vinyl surfaces where a high gloss finish, flexibility and outdoor durability are required. Ideal for fleet markings, vinyl upholstery decoration, PVC and acrylic containers. GLV series ink exhibit excellent screen stability.

Application Information

Thinning : May be used straight from the can but it is recommended to thin 5 - 15% by weight with GLV-1800 Thinner. For maximum lightfastness or outdoor durability, little or no thinning is recommended .

Additives : GLV-1700 Clear should only be used to increase transparency of colors. However, this will reduce the durability and lightfastness of the color. If required, use a small amount of GLV-1730 Process Clear ink to improve print quality.

Wash-Up : GLV-1800 Thinner
ITC-1840 Wash-Up

Coverage : Approximately 2100 sq.ft./1 U.S. Gallon using a 280/in. monofilament fabric.

Fabric/Stencil : 200 to 355 monofilament fabric . Direct and indirect photostencil or water soluble hand cut stencils are suitable.

Drying : By solvent evaporation. GLV Series air dries in 30 to 60 minutes. Allow more time when overprinting to avoid possible re-wetting of previous colors. For jet-drying applications, test Modified Acrylic AM-0000 Series.

Die Cutting/Creasing : Can be successfully die cut or creased but should be tested prior to production .

Packaging : Inks : 1 U.S. Qt / 0.94 Lt.
1 U.S. Gal. / 3.78 Lt.
Solvents : 1 U.S. Gal. / 3.78 Lt.
5 U.S. Gal. / 19.00 Lt.

CAUTION :

1. It is the printer's responsibility to pre-test the ink selected prior to engaging in a production run .
2. Refer to Material Safety Data Sheet for heavy metal content.

* Based on information received from our suppliers, these colors may contain the deliberate addition of heavy metals.

* Heavy metal free colors are available on request. The following price pages also list these same colors with a lead-free content.

Standard Colors

* GLV-1010	Red #032
* GLV-1020	Fire Red
GLV-1030	Brilliant Red
* GLV-1040	Bright Red
* GLV-1050	Permanent Red
* GLV-1060	Red #185
GLV-1080	Maroon
GLV-1110	Black
GLV-1120	White
* GLV-1140	Brown
* GLV-1220	Orange
* GLV-1240	Vermilion
* GLV-1250	Warm Red
* GLV-1300	Primrose Yellow
* GLV-1320	Lemon Yellow
* GLV-1340	Medium Yellow
* GLV-1420	Emerald Green
* GLV-1450	Forest Green
* GLV-1480	Dark Green
GLV-1520	Opaque Reflex Blue
GLV-1540	Peacock Blue
GLV-1560	Brilliant Blue
GLV-1570	Royal Blue
GLV-1580	Dark Blue
GLV-1620	Purple
GLV-1640	Cerise
GLV-1660	Magenta
GLV-1700	Clear
GLV-2110	Extra Opaque Black
GLV-2120	Extra Opaque White
GLV-2150	Yellow C
GLV-2200	Rubine Red C
* GLV-2250	Orange 021 C
GLV-2300	Rhodamine Red C
* GLV-2350	Red 485 C
GLV-2400	Purple C
GLV-2450	Blue 072 C
GLV-2500	Violet C
GLV-2600	Reflex Blue C
GLV-2700	Process Blue C
GLV-2800	Opaque Green C
GLV-2850	Green C

Transparent Colors

GLV-1090	Transparent Red
GLV-1290	Trans. Medium Yellow
GLV-1390	Trans. Primrose Yellow
GLV-1490	Transparent Green
GLV-1590	Transparent Blue
GLV-1690	Transparent Cerise
GLV-1790	Transparent Orange
GLV-1990	Transparent Purple

Process Colors

GLV-1130	Process Black
GLV-1330	Process Yellow
GLV-1530	Process Blue
GLV-1630	Process Magenta
GLV-1730	Process Clear

Thinners and Additives

GLV-1800	Thinner
GLV-1810	Fast Thinner
GLV-1820	Slow Thinner
DC-393	Gel Retarder

* For Fluorescent colors please refer to FV-0000 Series.



GLOSS VINYL INK

STANDARD COLOURS		QT.(0.94 L	GAL(3.78 L)	
CODE NO .	DESCRIPTION			
GLV-1010	RED #032	105.60	289.20	
GLV-1010NL	RED #032 (Lead Free)	121.45	332.55	
GLV-1020	FIRE RED	86.75	228.90	
GLV-1020NL	FIRE RED (Lead Free)	99.70	263.25	
GLV-1030	BRILLIANT RED	121.00	327.00	
GLV-1040	BRIGHT RED	76.95	211.60	
GLV-1040NL	BRIGHT RED (Lead Free)	88.15	243.55	
GLV-1050	PERMANENT RED	89.55	244.25	
GLV-1050NL	PERMANENT RED (Lead Free)	102.95	280.95	
GLV-1060	RED # 185	105.60	289.20	
GLV-1060NL	RED 185 (Lead Free)	121.45	332.55	
GLV-1080	MAROON	152.45	423.15	
GLV-1110	BLACK	59.45	152.60	
GLV-1120	WHITE	65.00	173.75	
GLV-1140	BROWN	65.00	175.65	
GLV-1140NL	BROWN (Lead Free)	74.80	202.00	
GLV-1220	ORANGE	72.00	186.55	
GLV-1220NL	ORANGE (Lead Free)	82.85	214.60	
GLV-1240	VERMILION	74.80	195.60	
GLV-1240NL	VERMILLION (Lead Free)	86.00	224.90	
GLV-1250	WARM RED	105.60	289.20	
GLV-1250NL	WARM RED (Lead Free)	121.45	332.55	
GLV-1300	PRIMROSE YELLOW	67.85	186.55	
GLV-1300NL	PRIMROSE YELLOW (Lead Free)	78.00	214.60	
GLV-1320	LEMON YELLOW`	67.85	186.55	
GLV-1320NL	LEMON YELLOW (Lead Free)	78.00	214.60	
GLV-1340	MEDIUM YELLOW	67.85	186.55	
GLV-1340NL	MEDIUM YELLOW (Lead Free)	78.00	214.60	
GLV-1420	EMERALD GREEN	71.35	192.35	
GLV-1420NL	EMERALD GREEN (Lead Free)	82.00	221.20	
GLV-1450	FOREST GREEN	71.35	192.35	
GLV-1450NL	FOREST GREEN (Lead Free)	74.55	221.20	
GLV-1480	DARK GREEN	71.35	192.35	
GLV-1480NL	DARK GREEN (Lead Free)	82.00	221.20	
GLV-1520	OPAQUE REFLEX BLUE	105.60	289.20	
GLV-1540	PEACOCK BLUE	61.55	169.30	
GLV-1560	BRILLIANT BLUE	76.95	211.60	
GLV-1570	ROYAL BLUE	84.60	255.65	
GLV-1580	DARK BLUE	61.55	169.30	

		QT.(0.94 L)	GAL(3.78 L)	
GLV-1620	PURPLE	89.55	237.85	
GLV-1640	CERISE	107.75	293.65	
GLV-1660	MAGENTA	95.80	262.90	
GLV-1700	CLEAR	61.55	183.35	
GLV-2110	EX-OPAQUE BLACK	61.55	183.35	
GLV-2120	EX-OPAQUE WHITE	59.15	178.25	
GLV-2150	YELLOW C	96.50	264.15	
GLV-2200	RUBINE RED C	136.40	310.95	
GLV-2250	ORANGE 021C	109.10	300.10	
GLV-2250NL	ORANGE 021C (Lead Free)	125.45	345.00	
GLV-2300	RHODAMINE RED C	141.30	341.10	
GLV-2350	RED 485C	106.95	293.65	
GLV-2350NL	RED #485C (Lead Free)	123.00	337.70	
GLV-2400	PURPLE C	113.30	310.95	
GLV-2450	BLUE 072C	95.15	261.65	
GLV-2500	VIOLET C	113.30	310.95	
GLV-2600	REFLEX BLUE C	106.95	293.65	
GLV-2700	PROCESS BLUE C	69.95	237.20	
GLV-2800	OPAQUE GREEN C	88.10	252.00	
GLV-2850	GREEN C	94.45	259.00	
PROCESS COLOURS		QT.(0.94 L)	GAL(3.78 L)	
GLV-1130	PROCESS BLACK	61.55	169.30	
GLV-1330	PROCESS YELLOW	102.15	279.55	
GLV-1530	PROCESS BLUE	67.85	186.55	
GLV-1630	PROCESS MAGENTA	95.80	262.90	
GLV-1730	PROCESS CLEAR	65.00	178.25	
TRANSPARENT COLOURS		QT.(0.94 L)	GAL(3.78 L)	
	TRANSPARENT RED	136.40	373.80	
GLV-1290	TRANSPARENT MED. YELLOW	109.80	298.15	
GLV-1390	TRANSPARENT PRIM. YELLOW	112.65	307.10	
GLV-1490	TRANSPARENT GREEN	76.95	211.60	
GLV-1590	TRANSPARENT BLUE	67.85	186.60	
GLV-1690	TRANSPARENT CERISE	102.85	279.55	
GLV-1790	TRANSPARENT ORANGE	105.60	287.85	
GLV-1990	TRANSPARENT PURPLE	85.35	225.70	
FLUORESCENT COLOURS		QT.(0.94 L)	GAL(3.78 L)	
FV-0900	FLUORESCENT MAGENTA	124.75	340.85	
FV-0910	FLUORESCENT ORANGE/RED	124.75	340.85	
FV-0920	FLUORESCENT GREEN	124.75	340.85	
FV-0930	FLUORESCENT CERISE	124.75	340.85	
FV-0940	FLUORESCENT CHARTREUSE	124.75	340.85	
FV-0950	FLUORESCENT RED	124.75	340.85	
FV-0960	FLUORESCENT ORANGE/YELLOW	124.75	340.85	
FV-0970	FLUORESCENT PINK	124.75	340.85	
FV-0980	FLUORESCENT ORANGE	124.75	340.85	
FV-0990	FLUORESCENT BLUE	124.75	340.85	
THINNER AND WASH UP		GAL(3.78 L)	19 Litre	
GLV-1800	THINNER	54.45	233.10	
GLV-1810	FAST THINNER	75.00	328.90	
GLV-1820	SLOW THINNER	61.60	264.00	
ITC-1840	INKTECH #60 WASH UP (16KG)	N/A	213.80	



CRP - 0000 SERIES

SUBSTRATES : CORRUGATED PLASTICS, FLUTED CO-POLYMER RESIN PLASTICS, POLYPROPYLENE.

APPLICATION : P.O.P./ DISPLAYS, REAL ESTATE SIGNS, BUS SIGNS.

Product Information

A fast drying high gloss ink designed for indoor or outdoor use. Suitable for corrugated plastic sheets manufactured from special co-polymer resins. CRP series inks exhibit excellent scuff, water and outdoor resistance.

Application Information

Thinning : May be used straight from the can but it is recommended to thin 5 - 15% by weight with CRP-1800 Thinner. Substitute CRP-1800 Thinner with CRP-1820 Slow thinner to improve screen stability. For maximum lightfastness or outdoor durability, little or no thinning is recommended.

Additives : CRP-1700 Clear should only be used to increase transparency of colors. However, this will reduce the durability and lightfastness of the color. Add 5% to 10% of DC-393 Gel Retarder to thinned ink to maintain screen stability.

Wash-Up: CRP-1800 Thinner
ITC-1840 Wash-Up

Coverage : Approximately 2100 sq.ft./1 U.S. Gallon using a 280/in. monofilament fabric.

Fabric/Stencil : 200 to 305 monofilament fabric. Direct and indirect photostencil or water soluble hand cut stencils are suitable.

Drying : By solvent evaporation . CRP-0000 Series dries within 30 minutes at normal room temperature or can be jet dried 20 to 45 seconds at 150 °F. to 200 °F. Allow more time between prints for multiple color jobs.

Die Cutting/ Creasing: Can be successfully die-cut or creased but should be tested prior to production.

Packaging : Inks : 1 U.S. Qt / 0.94 Lt.
1 U.S. Gal. / 3.78 Lt.

Solvents : 1 U.S. Gal. / 3.78 Lt.

CAUTION :

1. It is the printer's responsibility to pre-test the ink selected prior to engaging in a production run .
2. Refer to Material Safety Data Sheet for heavy metal content.

* Based on information received from our suppliers, these colors may contain the deliberate addition of heavy metals.

* Heavy metal free colors are available on request.

Standard Colors

- * CRP-1010 Red #032
- * CRP-1020 Fire Red
- CRP-1030 Brilliant Red
- * CRP-1040 Bright Red
- * CRP-1050 Permanent Red
- * CRP-1060 Red #185
- CRP-1080 Maroon
- CRP-1110 Black
- CRP-1120 White
- * CRP-1140 Brown
- * CRP-1220 Orange
- * CRP-1240 Vermilion
- * CRP-1250 Warm Red
- * CRP-1300 Primrose Yellow
- * CRP-1320 Lemon Yellow
- * CRP-1340 Medium Yellow
- CRP-1370 Extender Base
- * CRP-1420 Emerald Green
- * CRP-1450 Forest Green
- * CRP-1480 Dark Green
- CRP-1520 Opaque Reflex Blue
- CRP-1540 Peacock Blue
- CRP-1560 Brilliant Blue
- CRP-1570 Royal Blue
- CRP-1580 Dark Blue
- CRP-1620 Purple
- CRP-1640 Cerise
- CRP-1660 Magenta
- CRP-1700 Clear
- CRP-2150 Yellow C
- CRP-2200 Rubine Red C
- * CRP-2250 Orange 021 C
- CRP-2300 Rhodamine Red C
- * CRP-2350 Red 485 C
- CRP-2400 Purple C
- CRP-2450 Blue 072 C
- CRP-2500 Violet C
- CRP-2600 Reflex Blue C
- CRP-2700 Process Blue C
- CRP-2800 Opaque Green C
- CRP-2850 Green C

Transparent Colors

- CRP-1090 Transparent Red
- CRP-1290 Trans. Medium Yellow
- CRP-1390 Trans. Primrose Yellow
- CRP-1490 Transparent Green
- CRP-1590 Transparent Blue
- CRP-1690 Transparent Cerise
- CRP-1790 Transparent Orange
- CRP-1990 Transparent Purple

Process Colors

- CRP-1130 Process Black
- CRP-1330 Process Yellow
- CRP-1530 Process Blue
- CRP-1630 Process Magenta
- CRP-1730 Process Clear

Fluorescent Colors

- CRP-0900 Fluorescent Magenta
- CRP-0910 Fluorescent Orange\Red
- CRP-0920 Fluorescent Green
- CRP-0940 Fluorescent Chartreuse
- CRP-0950 Fluorescent Red
- CRP-0960 Fluorescent Orange \Yellow
- CRP-0970 Fluorescent Cerise
- CRP-0980 Fluorescent Orange
- CRP-0990 Fluorescent Blue

Thinners and Additives

- CRP-1800 Thinner
- CRP-1820 Slow Thinner
- DC-393 Gel Retarder
- CRP-2340 Adhesion Promoter



COROPLAST INK

STANDARD COLOURS				
CODE NO .	DESCRIPTION	0.94 L(Qt.)	3.78 L (Gal)	
CRP-1010	RED #032	118.20	320.60	
CRP-1010NL	RED #032 (Lead Free)	141.85	384.70	
CRP-1020	FIRE RED	96.50	264.15	
CRP-1020NL	FIRE RED (Lead Free)	115.85	317.00	
CRP-1030	BRILLIANT RED	118.20	322.50	
CRP-1040	BRIGHT RED	130.80	355.25	
CRP-1040NL	BRIGHT RED (Lead Free)	150.35	408.50	
CRP-1050	PERMANENT RED	114.00	310.95	
CRP-1050NL	PERMANENT RED (Lead Free)	136.85	373.15	
CRP-1060	RED # 185	118.20	320.60	
CRP-1060NL	RED 185 (Lead Free)	141.85	384.70	
CRP-1080	MAROON	173.45	475.15	
CRP-1110	BLACK	84.60	228.90	
CRP-1120	WHITE	90.90	245.55	
CRP-1140	BROWN	83.95	234.70	
CRP-1140NL	BROWN (Lead Free)	100.75	281.60	
CRP-1220	ORANGE	95.15	259.00	
CRP-1220NL	ORANGE (Lead Free)	114.10	310.85	
CRP-1240	VERMILION	99.35	271.20	
CRP-1240NL	VERMILLION (Lead Free)	119.20	325.50	
CRP-1250	WARM RED	118.20	320.60	
CRP-1250NL	WARM RED (Lead Free)	141.85	384.70	
CRP-1300	PRIMROSE YELLOW	95.15	259.00	
CRP-1300NL	PRIMROSE YELLOW (Lead Free)	114.10	311.65	
CRP-1320	LEMON YELLOW	92.35	252.60	
CRP-1320NL	LEMON YELLOW (Lead Free)	110.75	303.15	
CRP-1340	MEDIUM YELLOW	90.20	246.25	
CRP-1340NL	MEDIUM YELLOW (Lead Free)	108.30	295.45	
CRP-1370	EXTENDER	86.75	225.70	
CRP-1420	EMERALD GREEN	97.90	268.00	
CRP-1420NL	EMERALD GREEN (Lead Free)	117.50	321.65	
CRP-1450	FOREST GREEN	95.80	260.95	
CRP-1450NL	FOREST GREEN (Lead Free)	115.00	313.15	
CRP-1480	DARK GREEN	114.00	309.70	
CRP-1480NL	DARK GREEN (Lead Free)	124.40	337.85	
CRP-1520	OPAQUE REFLEX BLUE	118.20	320.60	
CRP-1540	PEACOCK BLUE	88.80	243.00	
CRP-1560	BRILLIANT BLUE	105.60	287.85	

CODE NO .	DESCRIPTION	0.94 L(Qt.)	3.78 L (Gal)	
CRP-1570	ROYAL BLUE	140.60	378.95	
CRP-1580	DARK BLUE	110.50	300.75	
CRP-1620	PURPLE	97.90	267.40	
CRP-1640	CERISE	117.55	321.20	
CRP-1660	MAGENTA	113.30	307.80	
CRP-1700	CLEAR	72.75	196.85	
CRP-2150	YELLOW C	102.85	282.10	
CRP-2200	RUBINE RED C	129.40	355.85	
CRP-2250	ORANGE 021 C	111.90	299.20	
CRP-2250NL	ORANGE 021C (Lead Free)	134.30	359.10	
CRP-2300	RHODAMINE RED C	129.40	355.85	
CRP-2350	RED #485C	116.80	320.60	
CRP-2350NL	RED #485C (Lead Free)	140.20	384.70	
CRP-2400	PURPLE C	106.30	291.10	
CRP-2450	BLUE 072 C	101.40	278.30	
CRP-2500	VIOLET C	124.50	341.10	
CRP-2600	REFLEX BLUE C	119.55	328.30	
CRP-2700	PROCESS BLUE C	97.25	266.75	
CRP-2800	OPAQUE GREEN C	99.35	273.15	
CRP-2850	GREEN C	104.95	287.25	
PROCESS COLOURS		0.94 L(Qt.)	3.78 L (Gal)	
CRP-1130	PROCESS BLACK	75.55	205.80	
CRP-1330	PROCESS YELLOW	105.60	286.60	
CRP-1530	PROCESS BLUE	82.50	223.15	
CRP-1630	PROCESS MAGENTA	113.30	307.10	
CRP-1730	PROCESS CLEAR	79.05	208.40	
TRANSPARENT COLOURS		0.94 L(Qt.)	3.78 L (Gal)	
CRP-1090	TRANSPARENT RED	181.15	474.45	
CRP-1290	TRANSPARENT MED. YELLOW	119.50	328.75	
CRP-1390	TRANSPARENT PRIM. YELLOW	124.30	341.75	
CRP-1490	TRANSPARENT GREEN	104.95	285.35	
CRP-1590	TRANSPARENT BLUE	104.95	285.95	
CRP-1690	TRANSPARENT CERISE	114.00	313.50	
CRP-1790	TRANSPARENT ORANGE	135.00	371.35	
CRP-1990	TRANSPARENT PURPLE	114.00	313.50	
FLUORESCENT COLOURS		0.94 L(Qt.)	3.78 L (Gal)	
CRP-0900	FLUORESCENT MAGENTA	116.30	318.85	
CRP-0910	FLUORESCENT ORANGE/RED	116.30	318.85	
CRP-0920	FLUORESCENT GREEN	116.30	318.85	
CRP-0930	FLUORESCENT CERISE	116.30	318.85	
CRP-0940	FLUORESCENT CHARTREUSE	116.30	318.85	
CRP-0950	FLUORESCENT RED	116.30	318.85	
CRP-0960	FLUORESCENT ORANGE/YELLOW	116.30	318.85	
CRP-0970	FLUORESCENT PINK	116.30	318.85	
CRP-0980	FLUORESCENT ORANGE	116.30	318.85	
CRP-0990	FLUORESCENT BLUE	116.30	318.85	
THINNER AND WASH UP		3.78 L (Gal)	18.9 L (5 Gal.)	
CRP-1800	THINNER	48.55	208.55	
CRP-1820	SLOW THINNER	39.70	147.05	
ITC-1840	INKTECH #60 WASH UP (16KG)	N/A	213.75	P.52



SUBSTRATES : PAPER, METAL, GLASS, WOOD, MASONITE, TREATED POLYPROPYLENE & POLYETHYLENE (P&P), PRESSURE SENSITIVE MATERIALS.

APPLICATION : OUTDOOR METAL SIGNS & DISPLAYS, LICENSE PLATES, NOVELTIES, PACKAGING CONTAINERS, REFLECTIVE SIGNAGE.

Product Information

A high gloss multi-purpose ink designed for long term outdoor application. Ideal for exterior traffic signs, POP/displays, treated (P&P) containers.

Application Information

Thinning : May be used straight from the can but it is recommended to thin 5% by weight with GLE-1800 Thinner. When more than 5% thinning is required, it is recommended to use GLE-1900 Thinning Varnish to maintain optimum gloss. For maximum lightfastness or outdoor durability, little or no thinning is recommended.

Additives : GLE-1700 Clear should only be used to increase transparency of colors. However, this will reduce the durability and lightfastness of the color. Use a small amount of GLE-1730 Process Clear ink to improve print quality, if required. To prevent ink skinning in can, spray a light mist of GLE-1950 Anti-Skinning Agent on the surface of ink in partially used cans. Repeat whenever ink can is opened for reuse.

Wash-Up : GLE-1800 Thinner
GLE-1840 Wash-Up

Coverage : Approximately 1300 sq.ft./1 U.S. Gallon using a 230/in. monofilament fabric.

Fabric/Stencil : 158 to 280 monofilament fabric. All stencil systems are suitable.

Drying : By oxidation in approximately 1 ½ to 4 hours for over printing or overnight before final stacking. Best rack-drying results are obtained when an ambient temperature is more than 20 °C (68 °F). Prints may be forced dried 15-20 min. in an oven with temperature not exceeding 120 °C (250 °F). Baking at temperatures higher than recommended may cause loss of gloss. To speed drying time under adverse humid or cold weather conditions, add approximately 40-50 grams of GLE-1880 Accelerator to a gallon of ink.

Die Cutting/Creasing : Can be successfully die cut or creased but should be tested prior to production .

Packaging : Inks : 1 U.S. Qt / 0.94 Lt.
1 U.S. Gal. / 3.78 Lt.
Solvents : 1 U.S. Gal. / 3.78 Lt.
5 U.S. Gal. / 19.00 Lt.

CAUTION :

1. It is the printer's responsibility to pre-test the ink selected prior to engaging in a production run .
2. Refer to Material Safety Data Sheet for heavy metal content.

* Based on information received from our suppliers, these colors may contain the deliberate addition of heavy metals.
* Heavy metal free colors are available on request. The following price pages also list these same colors with a lead-free content

GLOSS ENAMEL INK

GLE - 0000 SERIES

Standard Colors

- * GLE-1010 Red #032
- * GLE-1020 Fire Red
- GLE-1030 Brilliant Red
- * GLE-1040 Bright Red
- * GLE-1050 Permanent Red
- * GLE-1060 Red #185
- GLE-1080 Maroon
- GLE-1110 Black
- GLE-1120 White
- * GLE-1140 Brown
- * GLE-1220 Orange
- * GLE-1240 Vermilion
- * GLE-1250 Warm Red
- * GLE-1300 Primrose Yellow
- * GLE-1320 Lemon Yellow
- * GLE-1340 Medium Yellow

- GLE-1370 Extender Base
- * GLE-1420 Emerald Green
- * GLE-1450 Forest Green
- * GLE-1480 Dark Green
- GLE-1520 Opaque Reflex Blue
- GLE-1540 Peacock Blue
- GLE-1560 Brilliant Blue
- GLE-1570 Royal Blue
- GLE-1580 Dark Blue
- GLE-1620 Purple
- GLE-1640 Cerise
- GLE-1660 Magenta
- GLE-1700 Clear
- GLE-2150 Yellow C
- GLE-2200 Rubine Red C
- * GLE-2250 Orange 021 C
- GLE-2300 Rhodamine Red C
- * GLE-2350 Red 485 C
- GLE-2400 Purple C
- GLE-2450 Blue 072 C
- GLE-2500 Violet C
- GLE-2600 Reflex Blue C
- GLE-2700 Process Blue C
- GLE-2800 Opaque Green C
- GLE-2850 Green C

Transparent Colors

- GLE-1090 Transparent Red
- GLE-1290 Trans. Medium Yellow
- GLE-1390 Trans. Primrose Yellow
- GLE-1490 Transparent Green
- GLE-1590 Transparent Blue
- GLE-1690 Transparent Cerise
- GLE-1790 Transparent Orange
- GLE-1990 Transparent Purple

Process Colors

- GLE-1130 Process Black
- GLE-1330 Process Yellow
- GLE-1530 Process Blue
- GLE-1630 Process Magenta
- GLE-1730 Process Clear

Thinners and Additives

- GLE-1800 Thinner
- GLE-1880 Accelerator
- GLE-1900 Thinning Varnish
- GLE-1950 Anti-Skinning Agent

* Fluorescent colors available upon request.



GLOSS ENAMEL INK

STANDARD COLOURS

CODE NO .	DESCRIPTION	Qt.-0.94 L	Gal-3.79L
GLE-1010	RED #032	115.80	316.25
GLE-1010NL	RED #032 <i>(Lead Free)</i>	139.00	379.50
GLE-1020	FIRE RED	90.85	249.95
GLE-1020NL	FIRE RED <i>(Lead Free)</i>	109.00	299.90
GLE-1030	BRILLIANT RED	117.40	320.00
GLE-1040	BRIGHT RED	90.85	249.95
GLE-1040NL	BRIGHT RED <i>(Lead Free)</i>	104.55	287.45
GLE-1050	PERMANENT RED	105.40	286.80
GLE-1050NL	PERMANENT RED <i>(Lead Free)</i>	126.45	344.20
GLE-1060	RED # 185	115.80	316.25
GLE-1060NL	RED # 185 <i>(Lead Free)</i>	139.00	379.50
GLE-1080	MAROON	146.40	399.70
GLE-1110	BLACK	66.70	181.40
GLE-1120	WHITE	81.20	220.50
GLE-1140	BROWN	88.50	227.10
GLE-1140NL	BROWN <i>(Lead Free)</i>	106.20	272.55
GLE-1220	ORANGE	94.85	260.25
GLE-1220NL	ORANGE <i>(Lead Free)</i>	113.85	312.35
GLE-1240	VERMILION	94.85	261.75
GLE-1240NL	VERMILLION <i>(Lead Free)</i>	113.85	314.10
GLE-1250	WARM RED	115.85	316.25
GLE-1250NL	WARM RED <i>(Lead Free)</i>	139.00	379.50
GLE-1300	PRIMROSE YELLOW	94.85	261.75
GLE-1300NL	PRIMROSE YELLOW <i>(Lead Free)</i>	113.85	314.10
GLE-1320	LEMON YELLOW	94.85	261.75
GLE-1320NL	LEMON YELLOW <i>(Lead Free)</i>	99.00	314.10
GLE-1340	MEDIUM YELLOW	94.85	261.75
GLE-1340NL	MEDIUM YELLOW <i>(Lead Free)</i>	113.85	314.10
GLE-1350	OVERPRINT CLEAR	73.20	200.55
GLE-1370	EXTENDER	63.55	187.20
GLE-1420	EMERALD GREEN	76.40	220.50
GLE-1420NL	EMERALD GREEN <i>(Lead Free)</i>	91.70	264.50
GLE-1450	FOREST GREEN	90.85	249.95
GLE-1450NL	FOREST GREEN <i>(Lead Free)</i>	109.00	299.90
GLE-1480	DARK GREEN	86.90	233.80
GLE-1480NL	DARK GREEN <i>(Lead Free)</i>	104.25	280.50
GLE-1520	OPAQUE REFLEX BLUE	115.80	316.25
GLE-1540	PEACOCK BLUE	76.40	210.10

			Qt.-0.94 L	Gal-3.79L
GLE-1560	BRILLIANT BLUE		81.20	220.50
GLE-1570	ROYAL BLUE		103.00	280.20
GLE-1580	DARK BLUE		103.00	280.20
GLE-1620	PURPLE		91.70	253.65
GLE-1640	CERISE		109.40	296.45
GLE-1660	MAGENTA		123.00	332.60
GLE-1700	CLEAR		73.20	200.55
GLE-2150	YELLOW C		123.90	339.20
GLE-2200	RUBINE RED C		150.40	412.20
GLE-2250NL	ORANGE 021C (Lead Free)		152.50	417.60
GLE-2250	ORANGE 021 C		127.00	348.00
GLE-2300	RHODAMINE RED C		140.70	386.40
GLE-2350	RED 485 C		134.30	368.70
GLE-2350NL	RED 485 C (Lead Free)		161.25	442.40
GLE-2400	PURPLE C		128.70	353.95
GLE-2450	BLUE 072 C		108.80	300.90
GLE-2500	VIOLET C		112.60	309.70
GLE-2600	REFLEX BLUE C		114.25	312.60
GLE-2700	PROCESS BLUE C		96.55	265.45
GLE-2800	OPAQUE GREEN C	105.60	98.90	271.35
GLE-2850	GREEN C		101.30	278.75
COLOURS				
			Qt.-0.94 L	Gal-3.79L
105.60				
GLE-1130	PROCESS BLACK		66.70	181.40
GLE-1330	PROCESS YELLOW		121.45	326.60
GLE-1530	PROCESS BLUE		68.35	183.60
GLE-1630	PROCESS MAGENTA		112.60	303.75
GLE-1730	PROCESS CLEAR		73.20	200.55
TRANSPARENT COLOURS				
			Qt.-0.94 L	Gal-3.79L
GLE-1090	TRANSPARENT RED		152.85	419.50
GLE-1290	TRANSPARENT MED. YELLOW		117.45	320.00
GLE-1390	TRANSPARENT PRIM. YELLOW		121.45	330.35
GLE-1490	TRANSPARENT GREEN		103.00	280.20
GLE-1590	TRANSPARENT BLUE		90.85	249.95
GLE-1690	TRANSPARENT CERISE		124.65	342.10
GLE-1790	TRANSPARENT ORANGE		131.10	356.85
GLE-1990	TRANSPARENT PURPLE		103.00	280.20
FLUORESCENT COLOURS				
			Qt.-0.94 L	Gal-3.79L
GLE-0900	FLUORESCENT MAGENTA		128.70	354.00
GLE-0910	FLUORESCENT ORANGE/RED		128.70	354.00
GLE-0920	FLUORESCENT GREEN		128.70	354.00
GLE-0930	FLUORESCENT CERISE		128.70	354.00
GLE-0940	FLUORESCENT CHARTREUSE		128.70	354.00
GLE-0950	FLUORESCENT RED		128.70	354.00
GLE-0960	FLUORESCENT ORANGE/YELLOW		128.70	354.00
GLE-0970	FLUORESCENT PINK		128.70	354.00
GLE-0980	FLUORESCENT ORANGE		128.70	354.00
GLE-0990	FLUORESCENT BLUE		128.70	354.00
THINNER AND WASH UP				
			3.78 L	18.9L
GLE-1800	THINNER		52.45	191.15
ITC - 1840	INKTECH #60 WASH UP (16KG)		N/A	213.80



AM - 0000 SERIES

SUBSTRATES : PRESSURE SENSITIVE VINYL FILMS, VINYL COATED PRODUCTS, VINYL TOP-COATED POLYESTER FILMS, ACRYLIC, REFLECTIVE VINYL, FLEXIBLE VINYL AWNINGS, ABS, POLYCARBONATE.

APPLICATION : VINYL BANNERS, DECALS, SUB-SURFACE PRINTING, FLEXIBLE SIGNAGE, ACRYLIC DISPLAYS, FLEET MARKINGS, MEMBRANE SWITCH.

Product Information

A fast dry long term outdoor vinyl ink designed to print on a wide variety of vinyl and vinyl coated products. Ideal for fleet markings and membrane switches.

Application Information

Thinning : May be used straight from the can but it is recommended to thin 5 - 15% by weight with AM-1800 Thinner. Substitute AM-1800 Thinner with AM-1820 Slow Thinner to improve screen stability when shop conditions are hot. When printing on Polycarbonate, acrylics and PETG thinning with AM-3200 Anti-Crazing Thinner may prevent crazing on substrate. For maximum lightfastness or outdoor durability, little or no thinning is recommended.

Additives : AM-1700 Clear can be used to increase transparency of colors. However, this will reduce the durability and lightfastness of the color. Add 5 - 10% DC-393 Gel Retarder to thinned ink to maintain screen stability. If required, use a small amount of AM-1730 Process Clear ink to improve print quality.

Wash-Up : AM-1800 Thinner
ITC-1840 Wash-Up

Coverage : Approximately 2100 sq.ft./1 U.S. Gallon using a 280/in. monofilament fabric.

Fabric/Stencil : 200 to 355 monofilament fabric. Direct and indirect photostencil or water soluble hand cut stencils are suitable.

Drying : By solvent evaporation . AM-0000 Series air dries in 10 to 20 minutes or can be Jet-Dried to 20-45 seconds at 150°F to 200°F. Allow more time when overprinting to avoid possible re-wetting of previous colors.

Die Cutting/Creasing/Vacuum Forming : Can be successfully die cut or creased but should be tested prior to production. AM-0000 series has excellent vacuum forming characteristics. Gloss levels may increase during vacuum forming, depending on temperature and substrate used.

Packaging : Inks : 1 U.S. Qt / 0.94 Lt.
1 U.S. Gal. / 3.78 Lt.
Solvents : 1 U.S. Gal. / 3.78 Lt.

CAUTION :

1. It is the printer's responsibility to pre-test the ink selected prior to engaging in a production run .
2. Refer to Material Safety Data Sheet for heavy metal content.

* Based on information received from our suppliers, these colors may contain the deliberate addition of heavy metals.

* Heavy metal free colors are available on request.

Standard Colors

* AM-1010	Red #032
* AM-1020	Fire Red
AM-1030	Brilliant Red
* AM-1040	Bright Red
* AM-1050	Permanent Red
* AM-1060	Red #185
AM-1080	Maroon
AM-1110	Black
AM-1120	White
* AM-1140	Brown
* AM-1220	Orange
* AM-1240	Vermilion
* AM-1250	Warm Red
* AM-1300	Primrose Yellow
* AM-1320	Lemon Yellow
* AM-1340	Medium Yellow
AM-1350	Overprint Clear
* AM-1420	Emerald Green
* AM-1450	Forest Green
* AM-1480	Dark Green
AM-1520	Opaque Reflex Blue
AM-1540	Peacock Blue
AM-1560	Brilliant Blue
AM-1570	Royal Blue
AM-1580	Dark Blue
AM-1620	Purple
AM-1640	Cerise
AM-1660	Magenta
AM-1700	Clear
AM-2110	Extra Opaque Black
AM-2120	Extra Opaque White
AM-2150	Yellow C
AM-2200	Rubine Red C
* AM-2250	Orange 021 C
AM-2300	Rhodamine Red C
* AM-2350	Red 485 C
AM-2400	Purple C
AM-2450	Blue 072 C
AM-2500	Violet C
AM-2600	Reflex Blue C
AM-2700	Process Blue C
AM-2800	Opaque Green C
AM-2850	Green C

Transparent Colors

AM-1090	Transparent Red
AM-1290	Trans. Medium Yellow
AM-1390	Trans. Primrose Yellow
AM-1490	Transparent Green
AM-1590	Transparent Blue
AM-1690	Transparent Cerise
AM-1790	Transparent Orange
AM-1990	Transparent Purple

Process Colors

AM-1130	Process Black
AM-1330	Process Yellow
AM-1530	Process Blue
AM-1630	Process Magenta
AM-1730	Process Clear

Thinners and Additives

AM-1800	Thinner
AM-1820	Slow Thinner
AM-3200	Anti Crazing Thinner
DC-393	Gel Retarder

*For Fluorescent colors please refer to FV-0000 Series.



MODIFIED ACRYLIC INK

STANDARD COLOURS				
CODE NO .	DESCRIPTION	Qt.-0.94 L	Gal.3.78 L	
AM-1010	RED #032	108.40	294.30	
AM-1010NL	RED #032 (Lead Free)	124.70	338.45	
AM-1020	FIRE RED	95.80	263.50	
AM-1020NL	FIRE RED (Lead Free)	110.15	303.00	
AM-1030	BRILLIANT RED	108.40	294.30	
AM-1040	BRIGHT RED	106.30	292.40	
AM-1040NL	BRIGHT RED (Lead Free)	122.25	336.20	
AM-1050	PERMANENT RED	111.20	304.55	
AM-1050NL	PERMANENT RED (Lead Free)	127.95	350.25	
AM-1060	RED # 185	108.40	294.30	
AM-1060NL	RED 185 (Lead Free)	124.70	338.45	
AM-1080	MAROON	148.30	405.25	
AM-1110	BLACK	75.55	203.90	
AM-1120	WHITE	79.00	216.10	
AM-1140	BROWN	79.00	217.35	
AM-1140NL	BROWN (Lead Free)	90.90	249.95	
AM-1220	ORANGE	92.35	252.00	
AM-1220NL	ORANGE (Lead Free)	106.20	289.80	
AM-1240	VERMILION	86.00	234.70	
AM-1240NL	VERMILLION (Lead Free)	98.95	269.90	
AM-1250	WARM RED	108.40	294.30	
AM-1250NL	WARM RED (Lead Free)	124.70	338.45	
AM-1300	PRIMROSE YELLOW	86.00	235.95	
AM-1300NL	PRIMROSE YELLOW (Lead Free)	98.95	271.30	
AM-1320	LEMON YELLOW`	88.10	241.00	
AM-1320NL	LEMON YELLOW (Lead Free)	101.30	277.20	
AM-1340	MEDIUM YELLOW	88.10	241.00	
AM-1340NL	MEDIUM YELLOW (Lead Free)	101.30	277.20	
AM-1350	EXTENDER	86.75	238.55	
AM-1420	EMERALD GREEN	86.75	237.85	
AM-1420NL	EMERALD GREEN (Lead Free)	99.70	274.55	
AM-1450	FOREST GREEN	86.75	237.20	
AM-1450NL	FOREST GREEN (Lead Free)	99.70	271.70	
AM-1480	DARK GREEN	88.80	243.65	
AM-1480NL	DARK GREEN (Lead Free)	102.15	280.20	
AM-1520	OPAQUE REFLEX BLUE	108.40	294.30	
AM-1540	PEACOCK BLUE	78.35	211.60	
AM-1560	BRILLIANT BLUE	93.00	247.50	
AM-1570	ROYAL BLUE	100.00	272.50	

CODE NO .	DESCRIPTION	Qt.-0.94 L	Gal.3.78 L	
AM-1580	DARK BLUE	102.85	280.85	
AM-1620	PURPLE	103.50	282.70	
AM-1640	CERISE	137.00	375.10	
AM-1660	MAGENTA	128.00	347.55	
AM-1700	CLEAR	76.25	206.45	
AM-2110	EX-OPAQUE BLACK	76.25	206.45	
AM-2120	EX-OPAQUE WHITE	83.95	230.15	
AM-2150	YELLOW C	104.95	288.55	
AM-2200	RUBINE RED C	117.55	321.85	
AM-2250	ORANGE 021C	114.00	313.35	
AM-2250NL	ORNAGE 021C (Lead Free)	131.10	359.85	
AM-2300	RHODAMINE RED C	131.50	360.35	
AM-2350	RED #485C	111.20	305.20	
AM-2350NL	RED #485C (Lead Free)	127.85	350.90	
AM-2400	PURPLE C	117.55	321.85	
AM-2450	BLUE 072C	96.95	266.75	
AM-2500	VIOLET C	121.00	332.15	
AM-2600	REFLEX BLUE C	110.50	302.65	
AM-2700	PROCESS BLUE C	88.80	243.65	
AM-2800	OPAQUE GREEN C	94.45	259.00	
AM-2850	GREEN C	96.50	264.15	
PROCESS COLOURS		NET\$/ 0.94 L	NET\$/3.78 L	
AM-1130	PROCESS BLACK	83.95	230.85	
AM-1330	PROCESS YELLOW	113.30	310.95	
AM-1530	PROCESS BLUE	88.80	243.65	
AM-1630	PROCESS MAGENTA	116.10	316.75	
AM-1730	PROCESS CLEAR	83.20	228.25	
TRANSPARENT COLOURS		NET\$/ 0.94 L	NET\$/3.78 L	
AM-1090	TRANSPARENT RED	135.00	366.80	
AM-1290	TRANSPARENT MED. YELLOW	126.60	344.30	
AM-1390	TRANSPARENT PRIM. YELLOW	131.50	356.50	
AM-1490	TRANSPARENT GREEN	95.15	254.55	
AM-1590	TRANSPARENT BLUE	95.80	260.95	
AM-1690	TRANSPARENT CERISE	130.15	353.90	
AM-1790	TRANSPARENT ORANGE	153.15	420.60	
AM-1990	TRANSPARENT PURPLE	120.35	326.35	
FLUORESCENT COLOURS		NET\$/ 0.94 L	NET\$/3.78 L	
FV-0900	FLUORESCENT MAGENTA	124.75	340.85	
FV-0910	FLUORESCENT ORANGE/RED	124.75	340.85	
FV-0920	FLUORESCENT GREEN	124.75	340.85	
FV-0930	FLUORESCENT CERISE	124.75	340.85	
FV-0940	FLUORESCENT CHARTREUSE	124.75	340.85	
FV-0970	FLUORESCENT PINK	124.75	340.85	
FV-0980	FLUORESCENT ORANGE	124.75	340.85	
FV-0990	FLUORESCENT BLUE	124.75	340.85	
ADDITIVES		NET\$/ 0.94 L	NET\$/3.78 L	
AM-1860	ANTISCUFF	91.45	255.15	
DC-393	RETARDER	51.30	136.80	
THINNERS AND WASH UP		NET\$/ 3.78L	NET\$/ 19L	
AM-1800	THINNER	89.70	375.00	
AM-1820	SLOW THINNER	91.20	388.25	
AM-1830	EX-SLOW THINNER	126.50	620.60	
ITC-1840	INKTECH WASH UP (16KG)	N/A	213.75	



SUBSTRATES: LACQUER AND PYROXILLIN COATED STOCKS, CARD/PAPER, WOOD, TREATED POLYESTER.

APPLICATION: PAPER AND CARD DISPLAYS, GREETING CARDS, FOILS, BOOK COVERS, HOCKEY STICKS.

Product Information

A multi- purpose, hard finish nitrocellulose lacquer with excellent adhesion to a wide variety of substrates. GLL series ink has excellent opacity, high gloss with good mar resistance and is designed for indoor and medium term outdoor application.

Application Information

Thinning : May be used straight from the can but it is recommended to thin 5 - 15% by weight with GLL-1800 Thinner. Substitute GLL-1800 Thinner with GLL-1820 Slow Thinner to improve screen stability when shop conditions are hot. For maximum lightfastness or outdoor durability, little or no thinning is recommended.

Additives : GLL-1700 Clear should only be used to increase transparency of colors. However, this will reduce the durability and lightfastness of the color. If required, use a small amount of GLL-1730 Process Clear ink to improve print quality.

Wash-Up : GLL-1800 Thinner
ITC-1840 Wash-Up

Coverage : Approximately 2100 sq.ft./1 U.S. Gallon using a 280/in. monofilament fabric.

Fabric/Stencil : 200 to 300 monofilament fabric . Direct and indirect photostencil or water soluble hand cut stencils are suitable.

Drying : By solvent evaporation . GLL Series air dries in 20 to 40 minutes at normal room temperature or can be Jet-dried 20 to 45 seconds at 150 °F to 200 °F. Allow more time when overprinting to avoid possible re-wetting of previous colors.

Die Cutting/Creasing : Can be successfully die cut or creased but should be tested prior to production.

Packaging : Inks : 1 U.S. Qt / 0.94 Lt.
1 U.S. Gal. / 3.78 Lt.
Solvents : 1 U.S. Gal. / 3.78 Lt.

CAUTION :

1. It is the printer's responsibility to pre-test the ink selected prior to engaging in a production run .
2. Refer to Material Safety Data Sheet for heavy metal content.

* Based on information received from our suppliers, these colors may contain the deliberate addition of heavy metals.

* Heavy metal free colors are available on request.

Standard Colors

* GLL-1010	Red #032
* GLL-1020	Fire Red
GLL-1030	Brilliant Red
* GLL-1040	Bright Red
* GLL-1050	Permanent Red
* GLL-1060	Red #185
GLL-1080	Maroon
GLL-1110	Black
GLL-1120	White
* GLL-1140	Brown
* GLL-1220	Orange
* GLL-1240	Vermilion
* GLL-1250	Warm Red
* GLL-1300	Primrose Yellow
* GLL-1320	Lemon Yellow
* GLL-1340	Medium Yellow
* GLL-1420	Emerald Green
* GLL-1450	Forest Green
* GLL-1480	Dark Green
GLL-1520	Opaque Reflex Blue
GLL-1540	Peacock Blue
GLL-1560	Brilliant Blue
GLL-1570	Royal Blue
GLL-1580	Dark Blue
GLL-1620	Purple
GLL-1640	Cerise
GLL-1660	Magenta
GLL-1700	Clear
GLL-2150	Yellow C
GLL-2200	Rubine Red C
* GLL-2250	Orange 021 C
GLL-2300	Rhodamine Red C
* GLL-2350	Red 485 C
GLL-2400	Purple C
GLL-2450	Blue 072 C
GLL-2500	Violet C
GLL-2600	Reflex Blue C
GLL-2700	Process Blue C
GLL-2800	Opaque Green C
GLL-2850	Green C

Transparent Colors

GLL-1090	Transparent Red
GLL-1290	Trans. Medium Yellow
GLL-1390	Trans. Primrose Yellow
GLL-1490	Transparent Green
GLL-1590	Transparent Blue
GLL-1690	Transparent Cerise
GLL-1790	Transparent Orange
GLL-1990	Transparent Purple

Process Colors

GLL-1130	Process Black
GLL-1330	Process Yellow
GLL-1530	Process Blue
GLL-1630	Process Magenta
GLL-1730	Process Clear

Thinners and Additives

GLL-1800	Thinner
GLL-1820	Slow Thinner
GLL-1780	Sharp Printing Compound
GLL-1860	Anti-Scuff

* Fluorescent colors available upon request.

CODE NO .	DESCRIPTION	0.94 L(Qt.)	3.78 L (Gal)
GLL-1580	DARK BLUE	78.85	216.85
GLL-1620	PURPLE	89.65	239.00
GLL-1640	CERISE	112.55	297.30
GLL-1660	MAGENTA	115.10	307.15
GLL-1700	CLEAR	54.00	142.20
GLL-2150	YELLOW C	94.00	261.15
GLL-2200	RUBINE RED C	131.00	350.30
GLL-2250	ORANGE 021C	95.40	263.45
GLL-2250NL	ORANGE 021C (Lead Free)	109.70	303.00
GLL-2300	RHODAMINE RED C	131.00	350.30
GLL-2350	RED 485C	96.65	268.15
GLL-2350NL	RED #485C (Lead Free)	111.15	308.40
GLL-2400	PURPLE C	115.10	307.80
GLL-2450	BLUE 072C	89.00	244.80
GLL-2500	VIOLET C	129.75	346.25
GLL-2600	REFLEX BLUE C	110.65	294.95
GLL-2700	PROCESS BLUE C	82.00	218.00
GLL-2800	OPAQUE GREEN C	86.50	203.80
GLL-2850	GREEN C	85.85	235.50
PROCESS COLOURS		0.94 L(Qt.)	3.78 L (Gal)
GLL-1130	PROCESS BLACK	64.20	169.65
GLL-1330	PROCESS YELLOW	89.00	245.40
GLL-1530	PROCESS BLUE	71.85	192.35
GLL-1630	PROCESS MAGENTA	89.00	239.00
GLL-1730	PROCESS CLEAR	64.20	169.65
TRANSPARENT COLOURS		0.94 L(Qt.)	3.78 L (Gal)
GLL-1090	TRANSPARENT RED	129.75	350.30
GLL-1290	TRANSPARENT MED. YELLOW	99.20	263.45
GLL-1390	TRANSPARENT PRIM. YELLOW	115.10	307.15
GLL-1490	TRANSPARENT GREEN	84.55	218.00
GLL-1590	TRANSPARENT BLUE	80.75	213.35
GLL-1690	TRANSPARENT CERISE	115.10	307.15
GLL-1790	TRANSPARENT ORANGE	125.90	332.80
GLL-1990	TRANSPARENT PURPLE	104.90	279.80
FLOURESCENT COLOURS		0.94 L(Qt.)	3.78 L (Gal)
GLL-0900	FLUORESCENT MAGENTA	105.75	289.85
GLL-0910	FLUORESCENT ORANGE/RED	105.75	289.85
GLL-0920	FLUORESCENT GREEN	105.75	289.85
GLL-0930	FLUORESCENT CERISE	105.75	289.85
GLL-0940	FLUORESCENT CHARTREUSE	105.75	289.85
GLL-0950	FLUORESCENT RED	105.75	289.85
GLL-0960	FLUORESCENT ORANGE/YELLOW	105.75	289.85
GLL-0970	FLUORESCENT PINK	105.75	289.85
GLL-0980	FLUORESCENT ORANGE	105.75	289.85
GLL-0990	FLUORESCENT BLUE	105.75	289.85
ADDITIVE		0.94 L(Qt.)	3.78 L (Gal)
GLL-1780	SHARP PRINTING COMPOUND	56.15	149.00
GLL-1860	ANTI-SCUFF	75.85	199.85
DC-393	GEL RETARDER	46.65	124.35
THINNER AND WASHUP		3.78 L (Gal)	18.9 L (5 Gal.)
GLL-1800	THINNER	48.15	203.25
GLL-1820	SLOW THINNER	60.15	255.35
ITC-1840	INKTECH #60 WASH UP (16KG)	N/A	194.30



SUBSTRATES : SOME VINYL COATED PRODUCTS , RIGID AND FLEXIBLE VINYLs.

APPLICATION : NOVELTIES, BOOK COVERS , INFLATABLES

Product Information

A matte -finish multi- purpose vinyl ink formulated for printing on rigid and flexible vinyls and vinyl coated fabrics. Designed for indoor and medium -term outdoor exposure; e.g. bumper stickers, beach balls etc.

Application Information

Thinning : May be used straight from the can but it is recommended to thin 5 - 15% by weight with MAV-1800 Thinner. For maximum lightfastness or outdoor durability, little or no thinning is recommended.

Additives : MAV-1700 Clear should only be used to increase transparency of colors. However, this will reduce the durability and lightfastness of the color.

Wash-Up : MAV-1800 Thinner
ITC-1840 Wash-Up

Coverage : Approximately 2100 sq.ft./1 U.S. Gallon using a 280/in. monofilament fabric.

Fabric/Stencil : 150 to 280 monofilament fabric. Direct and indirect photostencil or water soluble hand cut stencils are suitable.

Drying : By solvent evaporation . MAV Series air dries in 30 to 60 minutes. Allow more time when overprinting to avoid possible re-wetting of previous colors.

Die Cutting/Creasing : Can be successfully die cut or creased but should be tested prior to production .

Packaging : Inks : 1 U.S. Qt / 0.94 Lt.
1 U.S. Gal. / 3.78 Lt.
Solvents : 1 U.S. Gal. / 3.78 Lt.
5 U.S. Gal. / 19.00 Lt.

CAUTION :

1. It is the printer's responsibility to pre-test the ink selected prior to engaging in a production run .
2. Refer to Material Safety Data Sheet for heavy metal content.

* Based on information received from our suppliers, these colors may contain the deliberate addition of heavy metals.

* Heavy metal free colors are available on request.

Standard Colors

* MAV-1010	Red #032
* MAV-1020	Fire Red
MAV-1030	Brilliant Red
* MAV-1040	Bright Red
* MAV-1050	Permanent Red
* MAV-1060	Red #185
MAV-1080	Maroon
MAV-1110	Black
MAV-1120	White
* MAV-1140	Brown
* MAV-1220	Orange
* MAV-1240	Vermilion
* MAV-1250	Warm Red
* MAV-1300	Primrose Yellow
* MAV-1320	Lemon Yellow
* MAV-1340	Medium Yellow
* MAV-1420	Emerald Green
* MAV-1450	Forest Green
* MAV-1480	Dark Green
MAV-1520	Opaque Reflex Blue
MAV-1540	Peacock Blue
MAV-1560	Brilliant Blue
MAV-1570	Royal Blue
MAV-1580	Dark Blue
MAV-1620	Purple
MAV-1640	Cerise
MAV-1660	Magenta
MAV-1700	Clear
MAV-2110	Extra Opaque Black
MAV-2120	Extra Opaque White
MAV-2150	Yellow C
MAV-2200	Rubine Red C
* MAV-2250	Orange 021 C
MAV-2300	Rhodamine Red C
* MAV-2350	Red 485 C
MAV-2400	Purple C
MAV-2450	Blue 072 C
MAV-2500	Violet C
MAV-2600	Reflex Blue C
MAV-2700	Process Blue C
MAV-2800	Opaque Green C
MAV-2850	Green C

Transparent Colors

MAV-1090	Transparent Red
MAV-1290	Trans. Medium Yellow
MAV-1390	Trans. Primrose Yellow
MAV-1490	Transparent Green
MAV-1590	Transparent Blue
MAV-1690	Transparent Cerise
MAV-1790	Transparent Orange
MAV-1990	Transparent Purple

Process Colors

MAV-1130	Process Black
MAV-1330	Process Yellow
MAV-1530	Process Blue
MAV-1630	Process Magenta
MAV-1730	Process Clear

Thinners and Additives

MAV-1800	Thinner
MAV-1810	Fast Thinner
MAV-1820	Slow Thinner
DC-393Gel	Retarder

* For Fluorescent colors please refer to FV-0000 Series.



MATTE VINYL INK

STANDARD COLOURS			
CODE NO .	DESCRIPTION	NET\$/0.94 L	NET\$/ 3.78 L
MAV-1010	RED #032	89.55	239.15
MAV-1010NL	RED #032 (Lead Free)	102.95	275.00
MAV-1020	FIRE RED	90.20	248.15
MAV-1020NL	FIRE RED (Lead Free)	103.80	285.35
MAV-1030	BRILLIANT RED	86.00	230.85
MAV-1040	BRIGHT RED	70.60	183.35
MAV-1040NL	BRIGHT RED (Lead Free)	81.25	210.85
MAV-1050	PERMANENT RED	90.90	250.00
MAV-1050NL	PERMANENT RED (Lead Free)	103.90	287.60
MAV-1060	RED # 185	89.55	239.15
MAV-1060NL	RED # 185 (Lead Free)	102.95	275.00
MAV-1080	MAROON	137.10	373.15
MAV-1110	BLACK	54.55	175.00
MAV-1120	WHITE	62.25	205.15
MAV-1140	BROWN	60.15	160.95
MAV-1140NL	BROWN (Lead Free)	69.20	185.00
MAV-1220	ORANGE	69.95	192.35
MAV-1220NL	ORANGE (Lead Free)	80.45	221.20
MAV-1240	VERMILION	81.10	212.25
MAV-1240NL	VERMILLION (Lead Free)	93.35	244.00
MAV-1250	WARM RED	89.55	239.15
MAV-1250NL	WARM RED (Lead Free)	102.95	275.00
MAV-1300	PRIMROSE YELLOW	70.60	191.75
MAV-1300NL	PRIMROSE YELLOW (Lead Free)	81.25	220.45
MAV-1320	LEMON YELLOW	70.60	191.75
MAV-1320NL	LEMON YELLOW (Lead Free)	81.25	220.45
MAV-1340	MEDIUM YELLOW	70.60	191.75
MAV-1340NL	MEDIUM YELLOW (Lead Free)	81.25	220.45
MAV-1370	EXTENDER	48.95	130.15
MAV-1420	EMERALD GREEN	73.40	198.00
MAV-1420NL	EMERALD GREEN (Lead Free)	84.50	227.80
MAV-1450	FOREST GREEN	73.40	198.10
MAV-1450NL	FOREST GREEN (Lead Free)	84.50	227.80
MAV-1480	DARK GREEN	74.85	205.15
MAV-1480NL	DARK GREEN (Lead Free)	86.00	235.95
MAV-1520	REFLEX BLUE	89.55	239.15
MAV-1540	PEACOCK BLUE	60.15	160.95
MAV-1560	BRILLIANT BLUE	79.95	218.00
MAV-1570	ROYAL BLUE	81.10	212.25
MAV-1580	DARK BLUE	64.80	178.10



MATTE VINYL INK - cont'd.

		0.94 L	3.78 L	
MAV-1620	PURPLE	86.75	238.55	
MAV-1640	CERISE	106.95	288.55	
MAV-1660	MAGENTA	105.60	287.25	
		0.94 L	3.78 L	
MAV-1700	CLEAR	60.85	165.45	
MAV-2110	EX-OPAQUE BLACK	77.00	210.00	
MAV-2120	EX-OPAQUE WHITE	81.85	223.15	
MAV-2150	YELLOW C	101.40	278.30	
MAV-2200	RUBINE RED C	117.50	323.20	
MAV-2250	ORANGE 021C	116.55	315.85	
MAV-2250NL	ORANGE 021C (<i>Lead Free</i>)	134.00	363.20	
MAV-2300	RHODAMINE RED C	129.70	356.50	
MAV-2350	RED 485C	108.80	297.50	
MAV-2350NL	RED 485C (<i>Lead Free</i>)	125.10	342.15	
MAV-2400	PURPLE C	116.55	317.40	
MAV-2450	BLUE 072C	98.45	266.75	
MAV-2500	VIOLET C	119.20	320.60	
MAV-2600	REFLEX BLUE C	112.65	309.65	
MAV-2700	PROCESS BLUE C	88.00	239.80	
MAV-2800	OPAQUE GREEN C	93.30	254.55	
MAV-2850	GREEN C	98.45	269.30	
	TRANSPARENT COLOURS	0.94 L	3.78 L	
MAV-1090	TRANSPARENT RED	143.20	392.50	
MAV-1290	TRANSPARENT MED. YELLOW	115.35	313.00	
MAV-1390	TRANSPARENT PRIM. YELLOW	118.25	322.45	
MAV-1490	TRANSPARENT GREEN	80.80	222.15	
MAV-1590	TRANSPARENT BLUE	77.65	195.90	
MAV-1690	TRANSPARENT CERISE	107.95	293.55	
MAV-1790	TRANSPARENT ORANGE	110.90	302.30	
MAV-1990	TRANSPARENT PURPLE	89.60	236.95	
	THINNER AND WASH UP	0.94 L	3.78 L	
MAV-1800	THINNER	54.45	233.15	
MAV-1810	FAST THINNER	75.00	329.45	
MAV-1820	SLOW THINNER	61.75	264.75	
MAV-1830	EX-SLOW THINNER	78.65	324.50	
ITC-1840	INKTECH #60 WASH UP (16KG)	N/A	213.80	



Special Color Matches available in all lines

**Please Note: All screen inks can be ordered by phone or email.
No shopping Cart on these items.**

SCRATCH-OFF INK

SCO - 0000 SERIES

SUBSTRATES: Cards, paper.
APPLICATION: Lottery tickets, games.
PRODUCT INFORMATION: An opaque scratch-off ink designed for overprinting on printed images. Suitable for lottery tickets, sweepstakes, games, direct mail coupons, etc. Prints can be removed easily with fingernail or coin and does not powder.

STANDARD COLOURS

CODE NO.	DESCRIPTION	0.94 L	3.78L
SCO-0060	EX-OPAQUE SILVER ADDITIVES	70.60	181.15
SCO-0030	RELEASE VARNISH	80.50	220.00
SCO-0070	HARDENER THINNERS AND WASH UP	60.00	156.00
		3.78L	19L
SCO-1800	THINNER	41.00	155.00
SCO-1820	SLOW THINNER	41.00	160.00
ITC- 1840	INKTECH #60 WASH UP (16KG)	-	213.80

Bronze Powders - Pastes - Flattening - Glow in the dark

INKTECH MISC. ITEMS		3.78 L
AL-7300	ALUMINUM POWDER EX-FINE	84.00
RG-4160	RICH GOLD POWDER EX-FINE	74.90
PG-9720	PALE GOLD POWDER EX-FINE	74.90
AL-8300	ALUMINUM PASTE	111.00
PG-8300	PALE GOLD PASTE	111.00
RG-8300	RICH GOLD PASTE	111.00
FL-005	UNIVERSAL FLATTENING POWDER	57.75
GP-1720	FLATTENING ADDITIVE - Qt. - 73.00	Gal.- 202.95



Bronze Powders



The addition of a small amount of solvent (correct for the vehicle being used) to the bronze powder will aid in making a smooth mixture and increase the brilliance of the finished job.

Many printers add the bronze powder to the desired vehicle until a heavy paste results. The paste is then thinned to screening consistency with the correct solvent.

Use the proper clear base (bronzing vehicle) and thinner, depending on the substrate to be printed. Use approximately 2-3 lbs of gold powder to 1 gallon of clear base and 1-1 1/3 lbs. of Aluminum powder to 1 gallon of clear base. For best results use a monofilament screen fabric of 180 mesh to 230 mesh.



INTERNATIONAL CORPORATION

160 Fenmar Drive Toronto, Ontario, M9L-1M6 Tel (416)743-4111 (877)465-6362 Fax :(416)743-1511

SCRATCH OFF INK

SCO - 0000 SERIES

Standard Colors

SCO-0060 Extra Opaque Silver

Thinners and Additives

SCO-1800 Thinner
SCO-1820 Slow Thinner
SCO-0030 Release Varnish

SUBSTRATES : CARD, PAPER

APPLICATION : LOTTERY TICKETS, GAMES

Product Information

An opaque scratch-off ink designed for overprinting on printing images. Suitable for lottery tickets, sweepstakes, games, direct mail coupons etc. Prints can be removed easily with fingernail or coin and does not powder.

Application Information

Thinning : May be used straight from the can or thin to required viscosity with SCO-1800 Thinner. Over thinning will reduce opacity.

Additives : SCO-0030, Release Varnish may be used to coat certain stocks prior to printing if Scratch-off ink does not release properly. If ink releases too easily, add 1 - 5 % of SCO-0070, hardener to ink and retest.

Wash-Up : SCO-1800 Thinner
ITC-1840 Wash-Up

Coverage : Approximately 1200 sq.ft./1 U.S. Gallon using a 150/in. monofilament fabric.

Fabric/Stencil : 110 to 196 monofilament fabric. It is recommended to use as coarse of a mesh as the detail will allow. Direct and indirect photostencil or water soluble hand cut stencils are suitable.

Drying : By solvent evaporation . SCO Series air dries in 15 to 40 minutes or can be force-dried in seconds at temperatures of 90 deg. F. to 170 deg. F. Use of excessive heat may cause ink not to scratch off.

Die Cutting/Creasing : N/A

Packaging : Inks : 1 U.S. Qt / 0.94 Lt.
1 U.S. Gal. / 3.78 Lt.
Solvents : 1 U.S. Gal. / 3.78 Lt.
5 U.S. Gal. / 19.00 Lt.

CAUTION :

1. It is the printer's responsibility to pre-test the ink selected prior to engaging in a production run .
2. Refer to Material Safety Data Sheet for heavy metal content.

Please Note: All screen inks can be ordered by phone or email. No shopping Cart on these items.

NAZDAR®

screenotec
CORPORATION



ADE Series Epoxy Screen Ink (2 Part)

Nazdar ADE Series Epoxy Screen Ink

ADE inks are formulated with high-quality epoxy resins for excellent adhesion to a wide range of hard-to-print substrates. ADE provides outstanding solvent, chemical and abrasion resistance. ADE is a two-part ink system and must be initiated with ADE677 catalyst prior to use.

SUBSTRATES: Epoxy, melamine, treated polyethylene, polypropylene, metals, glass, PC boards.

END USES: Ideal for electronic and industrial applications.

MESH: 200-305 monofilament polyester or stainless steel mesh.

STENCIL: Direct method photo emulsion or equivalent. Also, any solvent resistant film or photo emulsion.

INK PREPARATION: Before using ADE ink, add 1 part ADE677 Catalyst to 5 parts ink. Pot life of catalysed ADE ink is approximately 6-8 hours. ADE678 High Performance Catalyst and ADE679 Snowboard Catalyst - Contact Technical Service for special data sheet.

AIR DRY: 30-60 minutes at room temperature.

FORCE-DRY: 3-5 minutes at 150°-180°F. Baking ADE prints for 10 minutes at 300°-325°F will produce the hardest, most durable prints.

EXTENDERS / ADDITIVES: To extend colour and / or reduce pigmentation, add ADE26 Mixing/Metallic Clear. For printing halftones and fine details, add ADE90 Heavy Body Base. For best printing results, reduce ink with 5-15% (by weight) RE190 Thinner. To prevent drying in screen under hot, humid conditions, add RE182 sparingly.

CLEAN UP: SW37 Wash Up.

Description		kg.	US Gal
ADE10	Primrose Yellow	\$82.70	\$347.30
ADE11	Lemon Yellow	\$89.20	\$374.40
ADE114	Brown*	\$50.50	\$226.90
ADE12	Medium Yellow	\$84.90	\$347.30
ADE15	Yellow (GS)	\$115.10	\$586.80
ADE16	Yellow (RS)	\$147.60	\$608.90
ADE170	Clear Gloss		\$174.90
ADE172	Flat Clear*		\$240.10
ADE18	Scarlet Red		\$565.80
ADE19	Fire Red	\$83.60	\$316.60
ADE20	Brilliant Orange	\$85.30	\$326.80
ADE22	Ultra Blue	\$78.20	\$299.90
ADE26	Mixing/Metallic Clear	\$55.10	\$195.70
ADE315	Emerald Green	\$104.60	\$408.00
ADE358	Tinting White		\$258.50
ADE359	Tinting Black	\$69.80	\$263.00
ADE360	Orange	\$108.80	\$419.20
ADE361	Yellow	\$113.20	\$429.10
ADE362	Warm Red	\$109.50	\$414.00
ADE363	Rubine Red	\$78.90	\$295.20
ADE364	Rhodamine Red	\$99.60	\$370.90
ADE365	Purple	\$97.70	\$364.30
ADE366	Violet	\$98.60	\$370.90
ADE367	Reflex Blue	\$76.30	\$289.30
ADE368	Process Blue	\$74.70	\$284.10
ADE369	Green	\$93.90	\$360.20
ADE405	Brilliant Blue*	\$67.70	\$334.40
ADE435	Regal Blue	\$160.70	\$370.50
ADE456	HT Process Blue	\$79.70	\$303.70
ADE503	Permanent Red Y		\$536.30
ADE52	Opaque Black	\$57.50	\$210.20
ADE568	Permanent Magenta*		\$414.20
ADE578	Permanent Cerise		\$381.50
ADE586	Permanent Process Red	\$115.20	\$439.50
ADE62	Warm Red	\$84.80	\$319.40
ADE67	Reflex Blue	\$76.60	\$361.20
ADE75	Opaque White	\$51.50	\$223.90
ADE78	High Intensity White	\$50.90	\$258.50
ADE80	Process Yellow	\$90.70	\$382.30
ADE81	Orange*	\$140.80	\$541.70
ADE82	Carmine	\$98.20	\$369.30
ADE83	Magenta	\$150.60	\$337.20
ADE84	Maroon		\$435.80
ADE85	Green	\$76.80	\$295.40
ADE86	Blue (GS)		\$266.30
ADE87	Blue (RS)		\$286.10
ADE88	Violet	\$85.90	\$320.60
ADE89	Red Toner		\$390.20
ADE90	Heavy Body Base	\$65.70	\$245.10
Description		Half Pint	Litre
ADE677	Catalyst litre	\$29.10	\$121.10
ADE678	Glass Catalyst		\$152.20
ADE679	Snowboard Catalyst		\$113.20



NAZDAR

DA Series Nylon and Flock Screen Ink & DA Accelerator (2 Part)

Highly opaque and extremely flexible and elastic inks for printing and flocking most synthetic and natural textiles, includes waterproof nylon and other synthetics having a finish. (Pre-testing of waterproof nylon is recommended.) DA Series have virtually unlimited resistance to laundering and dry cleaning as well as ironing.

The DA Accelerator has been formulated to accelerate drying times of DA Series Nylon Inks.

SUBSTRATES: Cotton, cotton blends, synthetics, waterproof nylon, and finished synthetics.

END USES: Nylon jackets.

MIXING INSTRUCTIONS: DA Series is a two-part polymerizing system. All colours must be mixed with DA176 Catalyst in a proportion of 3.5 parts of colour to AT LEAST one part of catalyst BY WEIGHT. Catalyst DA176 is sensitive to moisture changes and should be stored in a cool, dry place. Catalyst should be kept tightly closed at all times. Use one quart of DA ink with a half pint of DA176 Catalyst and add up to 75 drops (1 gram) of DA Accelerator. Stir well.

FINISH: Gloss.

DRYING: DA Series will in most cases air-dry overnight for subsequent handling depending on ink/catalyst ratio. The ink will continue to cure for three to four days. Full resistance to washing and dry cleaning is effected approximately seven days after printing. Heat-curing at 300-325°F (148-160°C) is required for periods ranging from seven to 10 minutes. Correct use of DA Accelerator will reduce the drying time of DA Series Inks to four minutes at 300°F (149°C).

CODE NO.	DESCRIPTION	1 kilo	US. GALLON
DALF104	BRIGHT RED	check	
+ DA111	BLACK	74.00	346.00
+ DA112	WHITE	85.00	424.00
DA124	ORANGE	98.00	
DA134	MEDIUM YELLOW	97.00	429.00
DA142	EMERALD GREEN	96.00	
+ DA152	LIGHT BLUE	91.00	
+ DA156	BRILLIANT BLUE	79.00	
+ DA170	CLEAR	74.00	
+ DA176	CATALYST (1/2 PINT \$28.00)	96.00	297.00
DA1882	ACCELERATOR - 2 ounce - 77.00		U.S. Gal.
+ RE188	THINNER -----		inquire
+ RE189	RETARDER -----		inquire
+ RE187	THINNER -----		inquire

[click here for color card](#)

STENCILS: Direct emulsions, photographic stencils or water soluble knife cut film.

SQUEEGEE: 60-80 durometer, square-edged blade.

CLEAN UP: VF184 Screen Wash.

OPACITY: All colours have excellent opacity and may be printed onto black or other dark grounds.

COVERAGE: Approximately 500-600 sq. ft./gal., depending upon screen fabric mesh.

MESH: 110-200 monofilament mesh is recommended.

030323

NAZDAR

GC PLASTISOL INKS

[Click here for color chart](#)

PRODUCT FEATURES

- Multi-purpose Plastisol Inks for Direct and Indirect printing.
- Excellent elasticity
- Super Opaque colours
- Low residual odour
- Non-bleeding colours



PRODUCT DESCRIPTION

GC Plastisol is a soft, creamy ink designed for both direct and transfer printing applications either hot or cold peel. Plastisol has excellent coverage on dark fabrics, yet easily adjusts to a "softhand" finish on light or white fabrics. With the addition of one or two products Plastisol becomes a true Multi-purpose Plastisol. Excellent results can be obtained in direct printing Wet-on-Wet without any build-up colours.

DRYING

Direct printing on garments 325° F for 1-1/2 minutes transfer printing (cold and hot peel) 220-240°F for 20-60 seconds. (Note: the heat-transfer press provides the full curing). The cure on direct printed garments may be affected by the thickness of the ink deposit, heat fluctuations and the type of dryer. Too much heat may cause the dyes in the garment to migrate (colour bleeding), fabric scorching and shrinkage. A good test to see if the ink is cured is to stretch the cured print; if it stretches like a rubber band, then it has formed a continuous film and is fully cured. If it starts to break apart, then it is under cured. Additional passes through the dryer at the same temperature setting does not work. It is necessary to increase the temperature if the garment reaches 325°F, the Plastisol ink will be well cured.

TRANSFER APPLICATION

For regular transfers the recommended temperature is 360-375°F for 6 seconds applied under pressure. Let cool for a few seconds and peel. For Hot Split transfers the recommended temperature is 360°F for 6 seconds, applied under pressure. Peel paper immediately.

SUBSTRATES

Cotton and Poly/cotton blends, most open mesh knits but not materials that have been waterproofed.

FABRIC/STENCIL

For heavy deposit printing on dark garments use 86-139 Monofilament. For light deposit printing on white or light coloured garments use 157-245 Monofilament. For Hot-split transfer paper use 86-157 Monofilament. The recommended fabrics are to be used as a guideline only and to achieve the best results testing should be done. All stencil systems can be used, but direct photographic emulsions will provide the most durable stencil. Indirect stencils can be used.

THINNERS

1180-50 Thinner. Plastisol inks may be used straight from the can, but maximum 20% of thinner is recommended. For reducing viscosity when required.

CAUTION

Too much thinner may increase the curing requirements of ink resulting in fabric scorching, shrinkage, especially on 50-50 Poly/cotton fabric blends.

HEAT TRANSFER PAPER

TRANSFERT-75 COLD PEEL HEAT TRANSFER PAPER.

Size 25" x 38" -1.55 Per Sheet

TECHNIPLAST COLOURS		GALS
SP-1111	CASPER WHITE	85.00
SP-1110	PRIMROSE	96.70
SP-1112	LEMON	96.70
SP-1114	GOLDEN YELLOW	97.50
SP-1115	CHROME	96.70
SP-1118	ORANGE	104.15
SP-1123	SCARLET	96.70
SP-1125	BRIGHT RED	96.70
SP-1127	VERMILLION	104.15
SP-1128	DEEP RED	89.30
SP-1129	MAROON	104.15
SP-1135	GREY	89.30
SP-1142	DK GREEN	89.30
SP-1145	EMERALD	96.70
SP-1147	KELLY	91.75
SP-1151	S.O. LT BLUE	86.80
SP-1153	OPAQUE ARGO BLUE	89.30
SP-1154	NAVY BLUE	89.30
SP-1155	REFLEX BLUE	89.30
SP-1156	S.O. PROCESS BLUE	89.30
SP-1157	ROYAL BLUE	89.30
SP-1158	ULTRA BLUE	89.30
SP-1159	PURPLE	96.70
SP-1165	BROWN	89.30
SP-1170	BLACK	70.75
SP-11MG-P	METALLIC GOLD PALE	121.50
SP-11MG-R	METALLIC GOLD RICH	121.50
SP-11MS	METALLIC SILVER	121.50
SP-11GG	GOLD GLITTER	133.90
SP-11SG	SILVER GLITTER	133.90

Transfer Glue
1 lb. size - 65.00

Spot Cleaner
S.P.I.F. Superkleen

Removes cured plastisol from all textiles. Apply with spot cleaning gun. Gallon 94.00

TECHNIPLAST®

ADDITIVES

The 1100 series Plastisol ink may be used straight from the container but a maximum 2% of 1180-50 wetting agent thinner is recommended for reducing viscosity when required. Too much thinner may increase the curing requirement resulting in fabric scorching and shrinkage, especially on 50/50 polyester cotton. Using Mineral Spirits for thinning purposes will cause resin particles to swell, creating changes in viscosity which may cause poor opacity or blurred images. Plastobond - add 10-15% to Plastisol Ink for nylon printing. Powder Transfer adhesive - a bonding agent that promotes adhesion to the garment.

1. Allow 24-96 hours after test printing to evaluate ink for intended application.
2. If product requires overlapping coats, (multi-colors) test ink on substrate with over lapping colors.
3. Refer to MSDS sheet for heavy metal content.

FLUORESCENT TECHNI-COLOURS

		GALS
SP-11FB	FLUOR BLUE	110.35
SP-11FC	FLUORCHARTREUSE	110.35
SP-11FG	FLUOR GREEN	110.35
SP-11FM	FLUOR MAGENTA	110.35
SP-11FO	FLUOR ORANGE	110.35
SP-11FP	FLUOR PINK	110.35
SP-11FR	FLUOR RED	110.35

SPECIAL COLOURS

		GALS
SP-GLO	GLO-IN-THE-DARK	370.75
SP-11-298	POWDER BLUE	110.35
SP-11GR-C	GREEN SEA	110.35
SP-11MA	MAGENTA	110.35
SP-11RE	RED 185	110.35
SP-11RH	RHODAMINE	110.35
SP-11RU	RUBINE	110.35
SP-11TU	TURQUOISE	110.35
SP-11WR	WARM RED	110.35
SP-11485	485 RED	110.35
SP-032	RED 032	110.35
SP-021	ORANGE 021	110.35

TECHNI-PLAST ADDITIVES & BASES

		GALS
SP-1100-PR	HI CLARITY EXTENDER & BASE	59.50
SP-1100-OP	OPAQUE BASE	71.90
SP-1180-225	SOFTHAND CLEAR	59.50
SP-1180-50	WETTING AGENT	57.00
SP-13PA	PUFF ADDITIVE	266.50
SP-15AD	HOT SPLIT ADDITIVE	122.75
SP-1100-PB	PLASTOBOND (1 PT.)	79.35
SP-1100	HI DENSITY WHITE	142.60
SP-1100	HI DENSITY BLACK	136.40

Production Supplies - Solvents - Sprays

SOLVENTS - FOR THINNING AND WASH-UP

SOLVENT	GAL. (US)	5 GAL (US)
Mineral Spirits	14.95	63.50
Lacquer Thinners	16.85	75.00
Xylene	18.95	69.85
Toluene	18.95	69.85
Acetone G.C.	28.90	105.00
Universal Wash (Uniclean)	27.95	104.00
Econowash	16.70	53.90
M.E.K.	-	155.00
Butyl Cellosolve	38.35	-
Isopropyl alcohol	24.95	99.00
DA 2 alcohol	17.50	71.50
Inktech ITC 1840 Wash	-	213.75
SW-55 Universal Wash	-	142.00



	<p>Sprayway #82 Mist Type Spray Adhesive For T Shirts and similar fabric materials. Bonds easily to cloth, paper, cardboard, acetate, foil, plastic film, cork foam rubber and leather. Repositionable. Will not transfer to fabric or shift during printing. 13 oz. - 12.30 ea.</p>		<p>Sprayway #83 Web Type Spray Adhesive. A quick drying translucent tack that provides temporary hold ing of textile fabrics to the printing pallet. Printing can follow immediatly. Fabric strips immediately without staining. 13 oz. - 11.75 ea.</p>
--	---	--	--

	<p>Sprayway #957 Instant Screen Opener Opens up clogged screens. Works well on direct and indirect stencils and knife-cut films. 15 oz. 12.85 ea.</p>		<p>Sprayway #50 Glass Cleaner Formerly #40 Leaves no film, streaks, scratches, or residue. For use on copy boards, lenses, negatives, and stripping tables. Can be used safely on many surfaces including Formica, chrome, porcelain, and plastics. Contains no ammonia. 15oz. 7.60</p>		<p>SPRAYWAY C-60 SOLVENT CLEANER AND DE-GREASER Removes grease and tar, adhesive marks, crayon, lipstick, ink, fresh paint. Excellent to remove these spots from upholstered fabrics, rugs, clothing, painted surfaces, metals and other surfaces. 16 oz. - 8.95 Each</p>
---	--	---	--	---	---

Reusable Tempered Stainless Steel REGISTRATION GUIDES

For thin Stock Printing.
Hand table and Semi-Automatic machine use. It s easy to feed stock into these long lasting guides.
Holds stock firmly in register.
Instructions in package.
Sold in packages of 12. 19.50 per



Pkg. of 12 - 19.50

MIXING CANS

1/2 Pint with lid	2.25 ea.
1 Quart lined with lid	2.75 ea.
1 Gallon line with lid	5.65 ea.

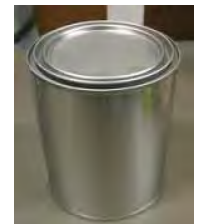

SQUEEGEES

URETHANE PLASTIC BLADES

POLY-C SQUEEGEE BLADES

Poly-C is a urethane plastic squeegee blade of highest quality that has been manufactured in Europe for over 20 years. It is long lasting and is used in hand and machine squeegee holders. Poly-C is color coded for different shore hardnesses.

•Red 60-65 duro soft •Green 70-75 duro medium •Blue 80 duro hard

SIZE	CUT PIECES	72"ROLL	144"ROLL
3/8"x2" Std. Rectangle	1.45 per inch	-	less 10%
3/16x7/8" V Shape	price on application		
3/16"x1" V Shape	price on application		



SQUEEGEES

Squeegees

Complete with handle
and Poly-C blade - 3.65 per inch
Handle only - 1.45 per inch



Complete
Squeegees made to
your Specifications.

available with soft, medium or hard blade

ONE MAN SQUEEGEE HANDLES - (Machine)

Handle only per inch
With Poly-C blade per inch

2 1/2" width	3 1/2" width
3.35 hdle. only	3.95 hdle. only
5.50 w/blade	5.95 w/blade



MACHINE SQUEEGEE

"Hunt Speedball" SCREEN FRAME HINGE CLAMPS #4513

Features a wide-wing thumb screw for firm and easy fastening to the screen frame. Easy to install, the clamp offers positive locking for perfect registry and precise control. (Installation screws not included.)

37.75 - Pair



WIPING AND CLEAN-UP RAGS

White Flannel Wipers

Soft and strong, White flannel cleaning cloths are produced from flannel bed sheets and pyjamas. Flannel rags are excellent polishing cloths for furniture manufacturers, polishing metals and printing presses or for buffing cars after waxing.

25 Lb. package -White Flannel Wipers - 53.35 pkg.



White Polo Wipers (T-Shirt)

Soft, low in lint, high in cotton content for excellent absorbency. Made from pure white t-shirts, these efficient multipurpose painters' and staining wiper has numerous other high end applications. Excellent for use with solvents or chemicals which may cause colours to run.



25 Lb. package -White Polo Wipers 61.50 pkg.

FLATTENING POWDERS

An excellent extra-fine powder used to flatten gloss finishes. Specially formulated to avoid hazing in clear vehicles and over-print vehicles.

FL005 - 1lb. - 57.75

ENVIRONMENTALLY SAFE BIODEGRADABLE PRODUCTS FOR SCREEN PRINTING



[click here to see instructions on use of all Eco Screen products](#)



ENVIRONMENTALLY SAFE BIODEGRADABLE PRODUCTS FOR SCREEN PRINTING

PRODUCT	DESCRIPTION	Image	PRICES		
			1 GALLON	5 GALLON	
Eco Degrease	DEGREASER Ready to use degreaser. Biodegradable. Water Soluble		55.00	-	
Eco Haze	HAZE REMOVERS Haze/Ghost remover. Strong and effective on stains. Non flammable. Biodegradable. Water soluble and rinseable.	Eco Haze	90.00	370.00	
Eco Strip#1	EMULSION REMOVERS Emulsion remover concentrate 1.20. Very strong and effective on emulsions and capillary films. Drain safe. Biodegradable. Also contains a degreaser.	Quart	74.00	259.00	
Eco Wash#1	SCREEN WASHES Screenwash for all inks. Drain safe. Non Flammable. Biodegradable. Water soluble.		Eco Wash #1	76.00	315.00
EcoWash#1-ELO	Economy screen wash for all inks. Same features as No.1.		Eco Wash #1-ELO	69.00	290.00
Eco Press Wash#222	PRESS SCREEN WASHES Special blend press wash for all inks. Non Hazardous. Biodegradable. Non Flammable.		-	240.00	
Eco Press Wash#33	Press wash for UV and textile inks. Same features as No.11.		69.00	297.00	
Eco Wet	WETTING AGENT Wetting agent/degreaser. Retains water on screen for easy application of capillary films. Water soluble. Biodegradable.		49.00	-	

MacDermid Alkemi

Chemicals & Solvents

AKEMI HAZE REMOVER is an extremely efficient, low caustic stain remover. It will effectively remove most types of ink and stencil stains with a minimum amount of effort.

5 Litre - 55.75 25 Litre - 229.00

Alkemi haze remover



degreaser

Alkemi Degreaser Concentrate: is a water-based mesh preparation that removes grease and contaminants from the screen prior to stencil application. It is offered in a standard concentration of 1:10/15 formula which is diluted with 10-15 parts of water for a ready to use product. **1 Litre - 38.00**



Alkemi A-7 SCREEN WASH is a high flash point, low odour, lowest evaporating and low VOC screen wash. Highly effective screen wash for manual printing and automatic machine (EN12921-3:2005 compliant),

[for full specs and data sheet - click here](#)

For cleaning of textile, graphics, and industrial inks.

5 Litre - 88.00 20 Litre - 275.00

CPS A-7 wash

Alkemi A-6 SCREEN WASH is a slow evaporating cleaner for most types of screen printable graphics inks. Also when used during reclaiming as a haze remover for light stains. **5 Litre - 76.00**

TEK-401C 1L

Emulsion Remover

A biodegradable, 100% water-soluble concentrate to be diluted 1:20 with water for fast removal of emulsions and capillary films **1 Litre - 61.35**



READY-MADE PRE-STRETCHED SCREENS - ALUMINUM

available in white or yellow mesh



20"x24" O.D.



20"x24" O.D.



23"x31" O.D.



25"x36" O.D.



custom aluminum frames available in any size

Lightweight • Maximum strength
Guaranteed Corner Weld Construction
Bow Resistant • Non-Warping
Easy to Clean • Quick Dry times
Life-Long Durability 1 1/2" x 1 1/2" x .062 Gauge Aluminum



- Finished screens with your image ready to print
- Re-stretch your old screens, or . . .
- Re-stretch, coat, and shoot your old screens

STOCK SIZE PRICES

MESH COUNT PER SQ. INCH	20" x 24" O.D. (17" x 21" I.D.)	23" x 31" O.D. (20" x 28" I.D.)	25" x 36" O.D. (22" x 33" I.D.)
110 white mesh only	47.95	59.95	85.95
156 white or yellow	49.95	62.80	89.90
195 " " "	53.50	66.80	97.25
230 " " "	53.80	66.80	97.50
255 " " "	53.95	66.90	97.80
280 yellow mesh only	54.40	67.50	98.50
305 yellow mesh only	56.40	68.00	99.75



MONOFILAMENT POLYESTER MESH

MONOFILAMENT POLYESTER fabrics are considered the best all-round material for screen printing. Next to stainless steel, it is the most dimensionally stable fabric. The inherent stability and strength of Monofilament Polyester make it ideal for both fine detail, close registration printing as well as general printing.

For adherence of indirect stencils the fabric surface should be treated with an abrasive grit such as ULANO #2 MICROGRIT or ULANO GEL 23.



SEFAR E-MESH

Monofilament Polyester Screen Fabric for general screen printing and textile screen printing.

MESH COUNT PER INCH	IN MICRONS	PRICE PER YARD			
		55" WIDE	62" WIDE	83" WIDE	92" WIDE
83 white	100	-	14.25	19.25	-
92 white	90	-	16.90	-	-
110 white	80	-	13.30	-	-
110 yellow	80	14.85	-	-	-
123 white	70	-	18.65	-	-
137 white	64	-	21.80	-	-
156 white	64	-	21.90	-	34.00
156 yellow	64	-	21.10	-	-
180 white	55	-	28.35	-	48.00
180 yellow	55	-	29.15	-	-
195 white	55	-	29.30	41.80	-
195 yellow	55	-	30.75	-	-
230 white	48	-	30.25	-	-
230 yellow	48	-	31.00	-	50.95
255 white	40	-	30.90	-	-
255 yellow	40	-	31.80	-	-
280 yellow	40	-	33.00	-	-

SCREEN AND FRAME MAKING AIDS

KIWOBOND Frame Adhesives

KIWOBOND 1000 HMT

A fast drying two-component adhesive for adhering mesh to wood, aluminum, and metal frames. 1000 HMT is the choice for high mesh tension and fast drying requirements. The low viscosity aids the application on very fine mesh counts, ideally above 305 tpi (120 tpcm). Not recommended for mesh counts below 156 tpi (60 tpcm). Technical sheet available.



1000HMT-750 Gram Set (adhesive & hardener)	54.85
1000HMT-4.25 Kilo Set (adhesive & hardener)	249.00
1000HMT-4.25 Kilo Frame Adhesive only	165.00
1000HMT-1 Kilo Hardener only	89.00



KIWOBOND 930 SET

KIWOBOND 930

A fast drying two-component adhesive for adhering mesh to wood, aluminum, and metal frames. Its medium viscosity enables easy application even on the coarsest mesh counts. Recommended for mesh counts below 260 tpi (100 tpcm) Technical Sheet available.

KIWOBOND 930 Set - 52.15

FOLDING MAGNIFIER For all Meshes

Fine Quality magnifier. Precision ground polished lens. Magnifies fabric threads. 12X. Folds up for easy storage



1" - 24.95

AUTOTYPE EXPOSURE CALCULATOR

An all-in-one test positive that helps you determine the best exposure time. The calculator's series of incremental gray neutral filters provides 5 exposure values with just one test exposure. Select one of them for the best stencil thickness, colour/hardness and definition. Features include a 65 line screen ruling and halftone dots in 10, 50 and 90% areas. Also the edge definition/resolution targets have a break in them and very fine type to assist your interpretation. A complete instruction guide is provided with each calculator.



92.00 ea.

SOLVENT RESISTANT Plastic Tape

Durable, white polyethylene reinforced cloth tape is pressure sensitive...has tremendous tack. Perfect for sealing off inside of frames, protecting edges and guides, etc. Molds into all crevices and corners and is simply removed. Tape is 2" wide and comes in 60 yard rolls.



2" x 60 yd. - 36.65

FABRIC PREP

ULANO GEL 23

An abrasive degreaser gel that combines the actions of Microgrit No. 2 and Screen Degreaser Liquid No. 3

The abrading action of Ulanogel 23 promotes better wetting of the fabric and adhesion of the stencil, and thus, longer press life. Its degreasing action removes dirt, dust, and oils from the fabric, reducing the risk of stencil failure and pinholing. Ulanogel 23 is ready-to-use and rinses off in hot or cold water. Its thixotropic character permits easy and effective preparation of larger screens held in a vertical position. Non-caustic - will not harm frames, fabric, or adhesives on stretch and glue frames. Recommended for use with all stencil systems on synthetic fabric only.



Gallon - 62.00

UNIVERSAL MESH-PREP

A non toxic fluid for degreasing and dramatically improving the wetting characteristics of all mesh types. Universal Mesh Prep is fast and easy to apply and harmless to the mesh. Developed for capillary films but suitable for all stencil systems.



5 Litre (1.32 gal.) Containers 68.00



ULANO #3 SCREEN DEGREASER LIQUID

A degreaser solution for all fabrics new or used, before stencil making - and as a degreaser after ink removal to speed the action of the stencil removal. Ready to use. No mixing. Foam action cleaning. Degreases effectively in hard water. Rinses clean with hot or cold water. Non caustic.



**Quart - 16.25
Gallon - 56.00**

SCREEN MAKING AIDS

SCREEN BLOCKOUT

MacDermid RUBY BLOCK OUT

Outstanding coatability and a high contrast red color are the key features of this premium solvent resistant blockout.

Autotype Ruby Block is a medium viscosity blockout for use on fine and medium mesh. It even coats and fills mesh openings without the drip-through that can lead to pinholes.

5 Litre - 48.00



ULANO 65 SCREEN FILLER

A water-soluble blockout with drying characteristics similar to indirect films to prevent loss of register. Same ink suitability as ULANO Presensitized Fotofilms.

Can be used for touch-ups when thinned with cold water. Can be used in unventilated rooms. Suitable for all ULANO Stencil Systems used with non-aqueous inks.

1 Gallon - 53.00



Kiwo Red Blockout

RED BLOCKOUT is our most economical, water soluble, and solvent resistant screen filler used for blocking out screens before printing. RED BLOCK-OUT can be used to cover large areas of the screen and to touch up pinholes. It is VOC free and contains no alcohol nor solvent.

1 Litre - 19.25
4 Litre - 43.00

SCREEN RECLAIMING

KIWO Mega-Clean Active Paste - 1 US Gal

KIWO Mega Clean Active : combination solvent and haze remover paste for the removal of most ink stains and emulsion residue in the screen. It has been formulated to be brushed onto the screen and rinsed off with water within a few minutes of application.

U.S. GAL. 102.10



ULANO #78 HAZE REMOVER PASTE

A ink haze and stencil residue remover that is effective on most inks and emulsions. Will also etch most mesh surfaces for film adhesion. Follow directions supplied with product to avoid damaging fabric. 1 kilo - 19.95



ULANO NO 4 STENCIL REMOVER LIQUID

Ready-to-use stencil remover liquid for fast action on all types of fabric, including metalized polyester.

Will not etch fabric. Contains no strong alkalis or hypochlorites. Ideal for use in tanks; will not attack fabric adhesives on rigid frames.

4 litre - 48.00 1 litre - 15.00



inktech PRE-MIXED SUPER PASTE

PRE-MIXED SUPER PASTE (Scented) - 4 Litre - 145.00

For cleaning/degreasing all types of meshes.

Super Paste paste will:

- Remove ink and stencil residues thus preventing ghost images, provided these are not due to thread damage by abrasion.
- Degrease and chemically roughen aluminum frames prior to screen stretching.



CPS Degreaser Concentrate:

1 Litre - 38.00

CPS Degreaser Concentrate: is a water-based mesh preparation that removes grease and contaminants from the screen prior to stencil application. It is offered in a standard concentration of 1:10/15 formula which is diluted with 10-15 parts of water for a ready to use product.

EMULSION COATERS

For Direct Emulsions. Exclusive design acts both as a scoop (to carry emulsion) and a coater.

Ideal for precise coating and for large volume users. Made of hard anodized aluminum.

All sizes available from 2" to 84".

Check for prices on sizes not listed.



SCOOP COATERS

8"	37.35	15"	59.45	24"	87.80
10"	43.65	18"	68.90	30"	106.75
12"	49.95	20"	75.20	36"	132.00



Hand Cut Stencil Film

ULANO S3S-STASHARP®

Solvent adhering knife-cut film on a 300-gauge polyester backing. For use with **water based and mild** solvent based inks.

SIZE	PRICE
40" x 300"	CHECK
Minimum order 6 rolls	

• EASY TO CUT

• EASY TO ADHERE

• EASY TO PEEL



MASKING FILM Rbylith 3mil & 5mil



This light-safe, knife-cut film is coated onto a polyester backing sheet. It can be cut manually or on a plotter to produce masks for film contacting, plate making, and film positives for photographic stencil production.

HANDCUT MASKING FILM

ROLLS	
SIZE	PRICE
3 mil 48"x 300"	253.00 roll
5 mil 48"x 300"	295.00 roll
3 mil 48"x1800"	1483.00 roll



PRESENSITIZED PHOTO STENCIL FILM



The world's most widely used indirect photo-stencil film.





FIVE STAR provides the screen printer with excellent edge definition and high resolution for a wide range of demanding screen printing applications including halftones and printed circuit board imaging.

The presensitized red gelatin emulsion of FIVE STAR includes a special protective coating to prevent blocking even at high humidity levels.

41" x 394" 364.00 48" x 394" 490.00

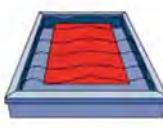

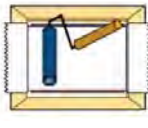
[Click here for instructions and data sheet](#)

Presensitized Film Steps					
					
EXPOSURE to UV light source gauge exposure time for your light source	HARDENING with activator liquid or powder	WASHOUT fine water spray use product direc.	DEGREASING use degreased screen see product direc.	BLOTTING roll with paper on raised surface	DRYING follow directions supplied w/roll



Saati SM 1000 Presensitized Photo Film

SM1000 is a red presensitized stencil film especially designed for the printed circuit manufacturer.

While the product need not be limited to this application, its excellent adhesion to coarse polyester fabric, with fine resolution and sharp definition that makes it the ideal choice for this industry.

2 mil backing sheet. Hybrid gelatin with double the durability of conventional films.

High resolution on polyester mesh. Adhesion is improved with Saati Direct Prep 3
SM1000 is the preferred film for printing metal parts and signs.

Application: For all Printing Applications. **Roll size 42"x 300" - 298.00 roll**



[Click here for instructions and data sheet](#)



ACTIVATOR HARDENER

4 Litre - 28.95



PRESENSITIZED PHOTO STENCIL FILM



PHOTO STENCIL EMULSION - DIRECT METHOD

KIWOCOL



KIWOCOL POLY PLUS 'S'

This is a high quality Diazo Photopolymer emulsion. It is ideal for all applications with solvent-based and UV inks, including fine detail and 4 colour process work.

Gallon - 105.65 Qts. 40.95

[see instructions and technical data here](#)

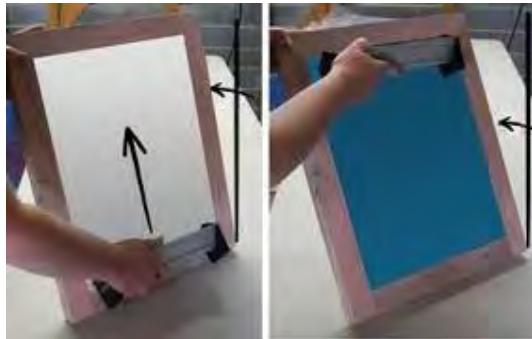

Coat Screen



Expose Screen



Wash out



GRAPHIC HU DIAZO PHOTO EMULSION

Dual-cure direct emulsion for printing UV-cured, plastisol, solvent based, and water-based inks. Excellent print definition on any mesh. 39% solids content.

Gallon - 97.85 Qts. 37.95



FX 88 ULANO

General purpose emulsion for mild solvent inks such as poster, enamel, and plastisol. Fast exposing Usable with low light source.
Blue. 28% solids - Gallon - 109.00

ULANO ORANGE



Gallon - 88.00 Orange 44-46% solids

Presensitized - ready to use
Textile Photo-polymer emulsion is formulated for imprinted sportswear printing. High viscosity and solids content makes Orange a good choice for coarse meshes. Very fast exposing. Resistant to plastisol inks, most washup solvents, and some water-based inks. Orange reduces light scatter.

[click here for spec sheet](#)



ITC-0017 INKTECH EMULSION

A high performance emulsion recommended for use with solvent, UV, plastisol, and water-based inks.

Excellent print definition on all mesh counts.

39 per cent solids content.

GALLON - 84.00

A.W.T. RACK-IT™ SERIES

Complete Line of Drying & Storage Racks



Click here for full details on all AWT Equipment

Note: Please check for landed Prices On all Equipment shown on this page.



Specialty Series - For Light Stock and Space Saving

Portable model Double Sided

Table Top- single side



DR-18-30

Table Top-Dble. sided



DR-18-50

Hanging model



DR-18-30WD

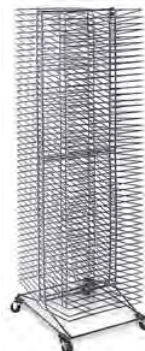

DR-18-100

Table Top- single side



DR-16-25

Specialty Models mesh openings 6"x10"

Model	Description
DR-16-25	Table Top Single side 25 shelves - 12"x16"
DR-18-30	Table Top Single side 30 shelves - 12"x18"
DR-18-50	Table Top double side 50 shelves - 10"x18"
DR-18-30WD	Hanging Model 30 shelves - 12"x18"
DR-18-100	Portable - double sided 100 shelves 10"x18"

Port-O-Rack Series Mid-Range Models

All-steel, portable rack for commercial shops and schools

- All steel welded frame construction
- Powder-coated, rust-resistant shelf finish
- Easy action shelves snap into frame
- Rubber bumpers assure proper shelf spacing
- Casters for in-shop mobility
- Shipped knocked-down for freight savings



DR-24-40A

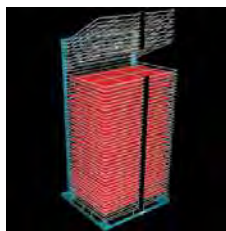

DR-24-50



DR-26-40

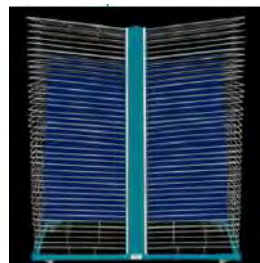

DR-24-80

Port-O-Racks mid range models

mesh openings 6"x6"

Model	Description
DR-24-40A	40 shelves - 18"x24"
DR-24-50	50 shelves - 18"x24"
DR-24-80	Double sided 80 shelves - 18"x24"
DR-24-100	Double sided 100 shelves-18"x24"
DR-26-40	40 shelves - 20"x26"
DR-26-50	50 shelves - 20"x26"

extra rubber bumpers available on all racks

Heavy Duty Models

A.W.T.'s Rack-It™ heavy-duty drying racks are the perfect choice for industrial drying applications. Built on a welded steel frame, these racks provide a safe and sturdy resting place for your substrates as they dry. Longer lasting than rubber, steel bumpers come standard on all of our heavy-duty racks and are welded to the outside of the shelf for maximum drying room. For smooth up/down operation, the individually adjustable shelf springs give you tension control over each shelf and all shelves feature a rust- and solvent-resistant, powder-coated finish to extend the life of the rack. Also available in heat resistant models for baking applications.



DR-36-40



DR-48-40

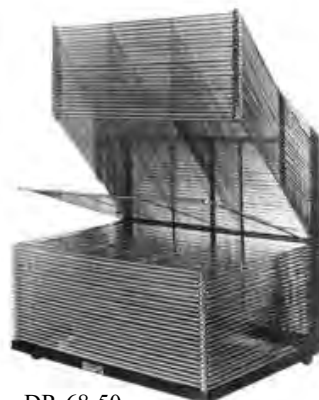

DR-68-50

Heavy Duty Models

Model	Description
DR-36-40	40 shelves 26"x36" mesh opening 4"x5"
DR-36-50	50 shelves 26"x36" mesh opening 4"x5"
DR-46-40	40 shelves 30" x46" Light Weight model mesh open. 7-3/4"x9-3/4"
DR-48-40	40 shelves 31" x 48" mesh opening 4"x5"
DR-48-50	50 shelves 31" x 48" mesh opening 4"x 5"
DR-50-50	50 shelves 37"x50" mesh opening 4"x5"
DR-55-50	50 shelves 42"x55" mesh opening 5"x5"
DR-68-50	50 shelves 45"x68" mesh opening 5"x5" extra heavy duty make
DR-80-50	50 shelves 52"x80" mesh opening 5"x5" extra heavy duty make



MANUAL PRINTING UNITS

Note: Prices shown are in U.S. \$ F.O.B. U.S.A. Contact us for landed prices in Cdn. dollars.

SERI-GLIDE™ ONE MAN SQUEEGEE UNIT Flat-Bed Manual Printing Unit With Aluminum Vacuum Table

Click here for full details
on all AWT Equipment

*Seri-Glide
Model SG-3545M shown
with optional screen*



SERI-GLIDE STANDARD FEATURES

- Rear clamp, micro-registration.
- All-aluminum, warp-resistant, rust resistant vacuum table provides a completely flat surface for fine quality hand printing.
- Quiet, maintenance-free vacuum motor.
- Up-front vacuum and blowback control.
- Adjustable counterbalance for easy screen lift.
- Smooth squeegee stroke action.
- Adjustable legs for easier printing, better ink control

SERI-GLIDE OPTIONAL FEATURES

- Upfront micro registration
- Electronic foot pedal control with timed variable automatic blowback controls

PRICES SHOWN ARE IN U.S. FUNDS & F.O.B. CHICAGO

Model	Maximum Print Area	PRICE	CRATE
SG-3545*M	35" x 45"	9,495.00	500.00
SG-4464*M	44" x 64"	10,595.00	650.00
SG-5280*M	52" x 80"	12,695.00	750.00
SG-5296*M	52" x 96"	14,995.00	850.00
SG-52120*M	52" x 120"	17,995.00	950.00
SG-52150*M	52" x 150"	19,995.00	1100.00
SG-52198*M	52" x 198"	26,995.00	1395.00
SG-52236*M	52" x 236"	32,900.00	1795.00
SG-60120*M	60" x 120"	19,995.00	1295.00
SG-60150*M	60" x 150"	21,995.00	1395.00
SG-60198*M	60" x 198"	28,995.00	1695.00
SG-60236*M	60" x 236"	33,990.00	2295.00
SG-72150*M	72" x 150"	24,225.00	1895.00
SG-72198*M	72" x 198"	31,995.00	2195.00
SG-72236*M	72" x 236"	36,900.00	2895.00

also available in sizes 60"x 96" and 72"x120"

HOT-FLASH™

*Moving Ahead
With Technology*

Textile Flash Cure Unit

Prices shown are in U.S. \$
F.O.B. Chicago
Ask for landed price in Cdn\$



*Hot-Flash AUTOTURN™
(Optional, Automatic head turning kit)*

ADVANTAGES

- Solid-state or standard controls
- Protective safety screen
- High-density radiant heat panels
- Heavy-duty height adjustment
- Casters and levelers on base
- Easy pivot head

NEW OPTION

Hot-Flash AUTOTURN™ Head-turning Kit

This optional feature will allow for automatic curing and free up your time to print approximately 20% more garments per hour.

The A.W.T. Hot Flash™ is unmatched in value and performance. Solid-state or standard temperature controls provide the consistent heat settings required by today's wide variety of plastisol formulas. High density radiant heat panels assure even heat distribution for fast cure rates.

A protective safety screen prevents accidental contact with the heat panels. Other quality features include a heavy duty height adjustment, an easy pivot head and a solid base designed for extra stability.

Optional Features

HF-AF Hot Flash autofast heat turn kit	- 1421.25
HF-SPP Spare Parts Pkg. 60 Hertz	- 65.00

HOT-FLASH TEXTILE FLASH CURE UNITS COMPLETE WITH STANDS

Catalog No.	Description	PRICE	CRATE
Hot Flash Panel Size 16"x16"			
HF-1615C	- with Standard Controller 115V, 1Ph, 60Hz.-1600Watts-	746.25	35.00
HF-16165S	-with Solid State Controller 115V, 1Ph, 60Hz.-1600Watts-	862.50	35.00
HF-1616S06	" Solid State Controller 220V, 1Ph,50/60Hz 1800Watts-	937.50	35.00
Hot Flash Panel Size 18"x18"			
HF-1818S06	with Solid State Controller 220V 1Ph,50/60Hz 2500Watts-	937.50	35.00
Hot Flash Panel Size 18"x24"			
HF-1824S06-	with Solid State Controller 220V,1Ph,50/60Hz.-3000Watt	1046.25	35.00
High Flash High Output Flash Panel Size 18"x24"			
HF-HO1824S06	High Output Solid State Control 220V,1Ph,50/60Hz.-5200Watt	1271.25	45.00

Textile Printers - Cure Unit

ECONO-TEX™ Series of Textile Equipment

Note: Prices shown are in U.S. \$
F.O.B. U.S.A. Contact us for
landed prices in Cdn. dollars.



SCREEN EQUIPMENT



ET-1516

One colour table-top textile printer. Maximum print size 15" x 16" with rugged all metal design and solid wood pallet.

\$310.00 u.s. funds, fob Chicago



ET-1516EXP

One colour expandable table-top textile printer. Maximum print size 15" x 16" with rugged all metal design and solid wood pallet.

\$550.00 u.s. funds, fob Chicago



ET-1516MC

Four colour single station table-top textile printer. Maximum print size 15" x 16" with rugged all metal design and solid wood pallet.

\$835.00 u.s. funds, fob Chicago

ET-HD - Additional printing head for one colour expandable table-top textile printer **EX-1516EXP - \$185.00**



ETF-1516MC

Four colour single station floor model textile printer. Maximum print size 15" x 16" with rugged all metal design and solid wood pallet.

\$1390.00 u.s. funds, fob Chicago



ETF-1516MC2

Four colour two station floor model textile printer. Maximum print size 15" x 16" with rugged all metal design and solid wood pallet. (Rotary heads with fixed pallets)

\$1730.00 u.s. funds, fob Chicago



ETMF-1516MC4

Four colour, four station, floor model Textile Printer. Max. print size 15" x 16" w/micro-registration & metal design. Solid wood pallet & shelf. Rotary Heads w/ Rotary Pallets.

\$3060.00 u.s. funds, fob Chicago

Other combinations and sizes available.

(Printers shown with optional frames.)

Note: **crating charges are included in all prices**



- OTHER PRODUCTS AVAILABLE

Contact us for models and sizes with pricing

[Click here for full specs & features on all AWT Printing Equipment](#)

Exposing

Vacuum Frames & Self-Contained Light Source Units



PRO-LIGHT
Series of Screen Exposing Units with Fluorescent or Optional Backlight Sources.

- Flexible "live" rubber vacuum blanket
- Quiet vacuum motor
- Direct method exposing units available

Cleaning

Manual & Automatic

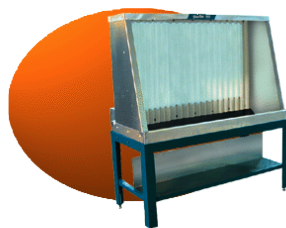

KLEEN-VIEW

Wash out Stand and Sink

- Stainless steel
- Custom sizes & systems
- High impact fiberglass back panel

Dryers



CURE-TEX

the economical approach to plastisol curing

- Solid-state temperature controls
- Adjustable infrared panel height
- Conveyor speed control

3D Parts Printer



VERSA-PRINT

Universal 3D or Piece Parts Screen Printer

- Pneumatic drive available
- Wide selection of mandrels available
- Perfect for mugs, coolers, promotional items, and fundraising projects

FOR POSITIVES & OVERLAYS

KIMOTO KIMODESK



Make screen positives without the need for cameras, processors or chemicals.

Simply create the artwork on your computer and print the positives with "KIMODESK" in your laser printer.

- Key benefits include:
- .003 polyester imparts dimensional stability and heat resistance.
 - both sides printable with anti-static properties.
 - excellent toner adhesion.

NOTE: Kimoto "Silkjet" sheets also available on special order, for making positives through an Inkjet printer.

DIRECT TO SCREEN FILM

GO DIRECT . . .



KIMODESK PRICES		
SIZE	UNITS	PRICE
8 1/2 X 11"	100	62.00
8 1/2 X 14"	100	79.00
11 X 17"	100	109.00
13 X 18 1/2"	100	147.00

CLEAR POLYESTER

CLEAR POLYESTER FILM OVERLAY - rolls only

A crystal clear polyester film used in the Graphic arts trade for overlays, transparencies, assembly of colour separations, or as a protective overlay for finished art comps. Will not tear or crack with age. Dimensionally stable and stays flat. No adhesive - non pressure sensitive.



GAUGE	50" X 50 ft.
.005	165.00per roll

PANTONE PLUS® formula guide

PANTONE® Where color comes from.

- includes:
- 2 fan decks - 1 coated and 1 un-coated.



New 2023 Edition
The "must have" guides for designers, printers and color decision makers – now with 224 brand-new colors! PLUS SERIES FORMULA GUIDES for selecting, specifying and matching solid PANTONE Colors. The new colors for fill out our expansive palette with beautiful new additions to the PANTONE line. Graphic designers, pre-press professionals and printers now have a total of 2390 color choices to unleash their passion and let their creativity soar.

PANTONE® color bridge match solids in process and RGB

-New 2023 edition

An Essential Guide for Designers, Pre-press and Printers – Newest edition now has 294 new Colors!



Bridge solid PANTONE Colors for process printing or web design. The PANTONE PLUS SERIES

- select and specify solid PANTONE Colors on coated stock
- determine how a PANTONE Color will appear when reproduced in CMYK
- create optimal display of PANTONE Colors on monitors and Web pages

New Color Bridge is now available with 2139 Pantone Spot colors. 2023 Editions

GG 6103B Color Bridge Coated	413.00
GG 6104B Color Bridge Un-coated	413.00
GP 6102B Color Bridge Coated&Uncoated-	679.00

2 Guide Set - No. GP1601B New 2023 Edition - as deccribed above	343.00
---	--------

AVAILABLE:	Number	Price
PANTONE METALLICS GUIDE - COATED -New 2023 edition	GG1507B-	289.00
PANTONE CMYK COATED & UNCOATED SET (4 COLOR PROC.)-2023 edition	GP5101C-	327.00
PANTONE PASTEL & NEONS GUIDE - COATED/UNCOATED -2023 edition	GG1504B-	202.00

Rhino Cutting Mat

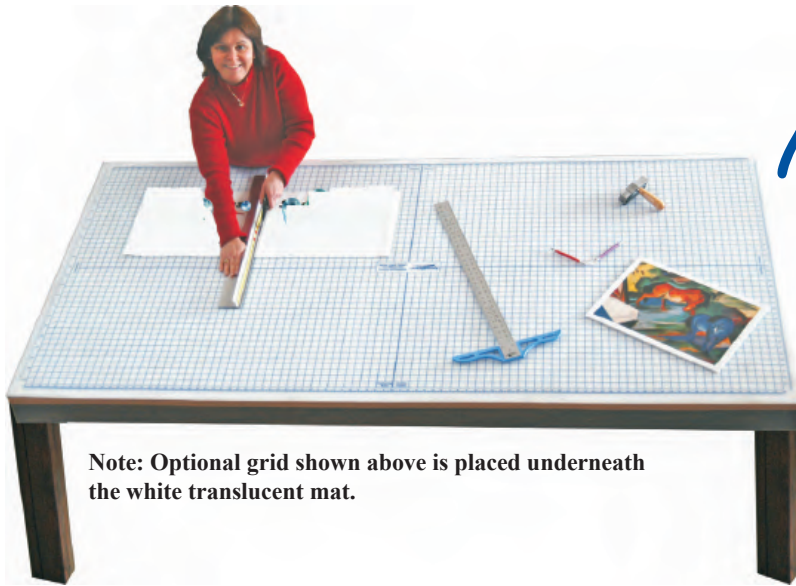

Note: Optional grid shown above is placed underneath the white translucent mat.

It's Self Healing

Straight Cutting - Mats won't gouge
 Unique Matte Finish - Easy on the eyes
 Seamless Self-Healing Virgin Polymer
 Protects Table Top - Blades Last Longer
 Thick .180 Inch Quality - Solvent Proof
 Our mats Roll Up for Easy UPS Shipping

MAT SIZES AND PRICES - UNPRINTED

2ft.x4ft.	4ft.x6ft.	4ft.x8ft.	4ft.x10ft.	4ft.x12ft.	4ft.x16ft.	5ft.x8ft.	5ft.x10ft.	5ft.x12ft.	6ft.x10ft.	6ft.x12ft.
78.00	213.00	282.00	359.00	417.00	563.00	359.00	437.00	524.00	524.00	632.00
Optional Grids - 4x2ft.-42.00		4x8ft.-61.00		4x12ft.-93.00		6x12ft.-170.00		Custom size grids available		

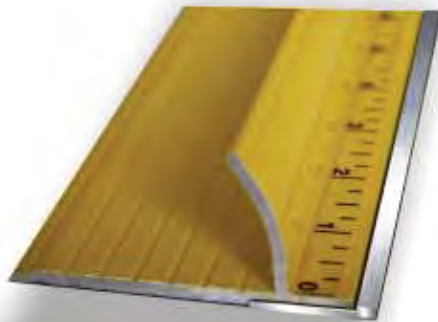

Steel Plate Married To Aluminum Straight Edge

Ultimate Steel Safety Ruler

Premium safety ruler features a steel plate insertion to the straight edge, along with a taller curved hand guard, extra wide base, steel cutting surface, and tough yellow powder coating.



28"	- 146.00
40"	- 183.00
52"	- 264.00
64"	- 293.00
76"	- 346.00
100"	- 483.00

RACKS FOR STORING VINYL ROLLS



Chrome plated wall mount
144.00

Heavy Duty - Holds 16 rolls of up to 30" width material. Saves floor space and allows proper storage for vinyl adhesion life. Supplied with adjustable screw mounting clips allowing for stud alignment in most walls.



545.00

Portable Chrome Plated Floor Rack with Handle

Heavy duty construction holds 16 rolls of 2" or 3" core material up to 1000 lbs.
 - Comes with 16 high impact plastic rings to prevent storage damage to rolls.
 - Has 9 ball caster rollers to allow easy movement while fully loaded.
 - Durable enough to hold 72" wide material. Proper storage of wide material dictates supporting rolls by the core to prevent damage to roll face coating.

ROLLER FOR VINYL



197.00

20" Roller Tray-Accommodates any size roll.

-Handles any width material up to 350 lbs.
 -to un-roll or re-roll material with ease without damage to the material.



Excel Knives - Blades - Tools

Excel K1 Aluminum Knife w/ #11 blade & safety cap



3.85

Light weight body fits with all standard craft knife blades including Xacto Knife. Includes 4 jaw aluminum chuck for more secure blade positioning and hold than your standard light duty knife; with a snug fitting, twist lock safety cap.

Excel #11 Blades

Sharper than average, these double honed blades are made from carbon steel and have a strong tip and flex without breaking, keeping their edge and tip longer, and are coated in a thin layer of oil for rust protection.



sword point

Pkg. of 5 - 2.95 -



Pkg. of 100 - 38.00



Excel #16 Blades

Sharper than average, these double honed blades are made from carbon steel and have a strong tip and flex without breaking, keeping their edge and tip longer, and are coated in a thin layer of oil for rust protection. Dispenser Pack of 15 - 9.75 -



chisel point



Pkg. of 100 - 38.00



K-18 Soft Grip Knife Kit w/5 extra #11 blades

K-18 Soft Grip Knife w/1 #11 blade

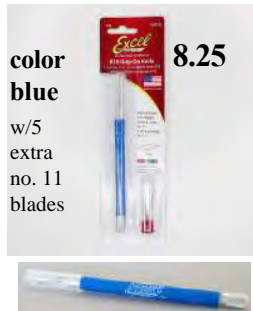

color blue
w/5 extra no. 11 blades

8.25



Light weight, aluminum body with comfortable **soft grip handle**. Fits all standard craft knife blades including Xacto Knife.

Includes 4 jaw aluminum chuck with rear blade release for a more secure blade and hold than your standard light duty knife.

Comes with a snug fitting twist lock safety cap



color blue
w/1 no. 11 blade

6.50



7.75 ea.

Excel K26 Fit Grip Knife w/ #11 blade

Unique like no other, the K26 knife has a rubberized soft ergonomic handle for long time use. It encases a strong aluminum body and four jawed chuck with rear blade release for a more secure blade placement. Includes a #11 blade and a snug fitting, shatter resistant safety cap

Excel Deluxe Retractable Knife w/ clip

14.95



Stylish light weight hobby knife, with a clean cutting blade for fine detail work, cutting, scoring, trimming, and stenciling with ultimate precision #66 replaceable blade

Extra Blades - #66 - (Pkg.2)-4.80



Excel
K71 Index Knife
w/ #11 blade
5.50

The Index Detail Knife is a small, lightweight, maneuverable knife designed with a oval-like hole handle to hug the users index finger while in use. This enables the user the maximum amount of control without losing any of the comfort.

Excel Swivel Knife

8.25



for precision cutting, trimming, and stripping of paper, plastic, wood, cloth, and film. Textured grip for ease of use.

Replacement Blade for Excel Swivel knife
#64 blade - pkg.2 - 2.95 pkg.



Mahl Stick

A necessity if painting fine details is important to your work. This 30" inch mahl stick is used to keep a steady hand at close proximity to your project. It includes 3 ten inch sections that screw into each other, perfect for tight storage or travel. Rubber tip is used to protect artwork.



22.75

Excel Pounce Wheels



The versatile head can be locked for straight line work or loose to allow for circles or curved designs, **10.95ea.**

OLFA Cutters and Knives

WITH AUTO-LOCK AND BLADE DISPOSAL CASE

OLFA MODEL A

Ideal for draftsmen, artwork, decorators,

Model A Knife 7.10

Click-stop action.
13 Snap-off points

AB50B Blades-Regular Pk.50-22.70 - AB10B Pk.10 -5.95
ABB50B Carbon Blades-Pk.50-26.10- ABB10B Pk.10-7.35
AB50S Stainless Steel-Pk.50-31.75 AB10S Pk 10-8.35



OLFA MODEL L-1

Heavy duty carton opener also cuts vinyl sheets and leather.

Set screw secures blades.
24 snap-off points.

L-1 Knife - 10.65

LB 10 B Blades - Standard Pkg. 10 7.90
LBB10B Blades - Carbon Pkg. 10 9.50
LB 50 B Blades - Standard Pkg. 50 30.70
LBB50B Blades - Carbon Pkg 50 34.95



OLFA MODEL L-2

Utility Knife with Rubber Grip. A non-slip rubber grip fits comfortably and securely in the hand. Set screw secures blades.

L-2 Knife - 12.25

LB 10 B Blades - Standard Pkg. 10 7.90
LBB10B Blades - Carbon Pkg. 10 9.50
LB 50 B Blades - Standard Pkg. 50 30.70
LBB50B Blades - Carbon Pkg 50 34.95



OLFA ART KNIFE AK-1 AK-1 Knife 7.25

For fine art work.
Comes with 5 blades.

KB Blades - Pkg. 25 - 5.95



OLFA SILVER - Model: SVR 2 - 10.35

Standard type snap-off blade cutter. Stainless steel holder is tough and durable. The good looking slim body assures a positive grip. (With 2 extra blades).

AB 10 B Blades - Pkg. 10 - 5.95
AB 50 B Blades - Pkg.50 22.70
ABB 50B Carbon Blades-50 26.10

STAINLESS RUST-RESISTANT KNIFE



OLFA STAINLESS STEEL SNAP-OFF GRAPHICS KNIFE - MODEL SAC-1



11.95

Ultra thin cutter is the tool of choice for graphic artists and sign making professionals. The acute 30 degree angle blades easily cuts cardboard, plastics and foam boards. Features an auto lock, pocket clip and blade snapper.

A1160B Snap Off Blades for SAC-1 KNIFE - 10.35 Pkg.10



OLFA COMPASS CUTTER -CMP-1 - 11.35

Cuts precise circles from 0.4" to 5.8" diameter. (1 to 15 cm.) Special rubber pad for preventing a pin hole.

COB-1 Blades - Pkg.-15 - 5.95

CUTTING TOOLS

CORO-CLAW™ Cutters



Coro Claw Deluxe 4 mil flute cutter - **25.95 ea.**
replacement blade - 10.95 ea.



Coro Claw 10 Mil flute cutter - **42.75 ea.**
replacement blade- 21.95 ea.

see videos-click here

OLFA MODEL L-1

Heavy duty carton opener also cuts vinyl sheets and leather.

Set screw secures blades.
24 snap-off points.

L-1 Knife - 10.65

LB 10 B Blades - Standard Pkg. 10 7.90
LBB10B Blades - Carbon Pkg. 10 9.50
LB 50 B Blades - Standard Pkg. 50 30.70
LBB50B Blades - Carbon Pkg 50 34.95



Our **Biddi Safety Knife** is used to cut banner material, vinyl, paper, film and most other thin and flexible material. Biddi is short for Bi Directional knife because you can cut forward and backwards with it. **21.95**
replacement blades - 9.95 ea.



OLFA PLASTIC CUTTER PC-L

OLFA PLASTIC CUTTER PC-L

Heavy duty plastic/laminate cutter designed as a scoring tool for sheet plastic and laminates. Allows for the precise breaking of plastics. Ratchet wheel for secure blade extension, retraction, and positioning.



PC-L cutter (w/3 blades) **14.25**
PB-800 blades (pkg.3) **5.95**



OLFA TS-1 TOP SHEET CUTTER

This new Top Sheet Cutter is a smartly engineered innovative tool that offers a unique way to cut only a single top sheet of material. Cuts newsprintpaper, cardstock, thin films, plastic sheeting, and tape. Blade storage is easily accessible in the handle of the knife.

TS-1 Cutter - 13.70 Blades-TSB-1 - 3.75 pkg./5

[click here for complete descriptive information](#)

OLFA SK-10 CONCEALED BLADE SAFETY KNIFE



Concealed blade safety knife featuring an adjustable blade positioning design which allows for 4 cutting points on a single-edge utility blade. Highly productive, it delivers 4x's more cuts than a single-edge, fixed blade "gooseneck" safety knife
SK-10 Knife - 13.65
Blades - SKB-10B - 8.45 pkg./10

Retractable Razor Scraper Heavy Duty



- Metal Body-Brass Slider
- locks in 3 positions.
- Scrapes and cleans windows and other surfaces.
- Replaceable w/ a single edged razor blade. 4.50 ea.

Razor Scraper Blades



-single edge

-high carbon steel
-precision ground
PKG. 100 - 23.95



8" Super Sharp Scissors

Long lasting - Stainless steel
Sharp blades for crisp cut
Moulded handle for comfort grip.

5.95

ART SUPPLIES

STABILO PENCIL



Write on all surfaces . . Paper .. Photographics .. Photostats .. Mylar .. Cellophane
 • Porcelain • Vellon • Glass • Film • Plastic.

The best pencil for laying out on glass or plastic signs. Makes a thin line, easily removed.
 Available in: White Blue Black Red Graphite Green Yellow Orange

Each - 2.75 29.95 box of 12

Curved Point Tweezers - 6"



For accurate control in sorting, probing, and precision work. Needle sharp - Light tension.
 Curved point surgical steel. 6 inches

7.70 ea.



Sharp Point Tweezers - 4 3/4"

For accurate control in sorting, probing, and precision work. Needle sharp - Light tension. Surgical Steel.

7.70 ea.



CHALKMARK[®] GF 290

5 Mil Black Chalkboard Vinyl

For use with soft chalks, & fluorescent liquid markers.
 Transforms most smooth surfaces into a removable Chalkboard.
 Printable with white UV curable inks.
 High performance revolvable adhesive with exceptional bond.
 Removes cleanly from most surfaces.
 Compliant with CPSIA 2008, RoHS and REACH

Product No.	Roll Size	Roll Price-25yds.
290-4875	48"x75 ft.	449.00 (17.96 yd)

Summary: GF 290 ChalkMark™ vinyl is a 5.0 mil matte black embossed chalkboard vinyl with a clear high-tack removable adhesive on a 90# liner. The 5.0 mil ChalkMark vinyl is designed for use with soft chalks and liquid chalk markers, and has a washable surface. The HTR adhesive works great on smooth painted drywall, plastic a-frame signs, metals and glass. ChalkMark™ is commonly used to produce decorative wall graphics covering large areas for menu boards or murals. GF 290 ChalkMark can also be used to create promotion graphics, plasticade signs, point-of-purchase graphics and craft cut shapes and decals.